

IF IT WORX, IT'S



# USER MANUAL

COLOUR PRINTER 

## P-C3060DN

Print  
A4



**P-C3060DN**

## **Advanced Operation Guide**

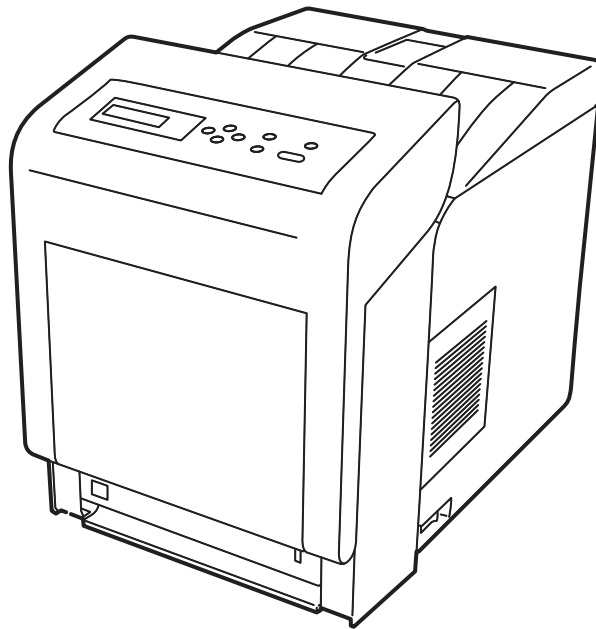



# Contents

---

<b>1</b>	<b>Handling Paper</b>	
	General Guidelines .....	1-2
	Selecting the Right Paper .....	1-4
	Special Paper .....	1-7
	Paper Type .....	1-13
	Loading Paper .....	1-14
<b>2</b>	<b>Using the Operation Panel</b>	
	General Information .....	2-2
	Understanding the Operation Panel .....	2-3
	Keys .....	2-6
	Using the Menu Selection System .....	2-8
	Setting a Mode Selection Menu .....	2-10
	Report Print .....	2-11
	USB Memory (USB memory selection) .....	2-16
	Custom Box (Using a Custom Box) .....	2-18
	Job Box .....	2-22
	Counter (Viewing the counter value) .....	2-28
	Paper Settings .....	2-29
	Print Settings .....	2-37
	Network (Network settings) .....	2-47
	Optional Network (Optional Network settings) .....	2-56
	Device Common (Selecting/Setting the common device) ....	2-61
	Security .....	2-79
	Job Accounting (Job Accounting selection/setting) .....	2-87
	Administrator (Administrator settings) .....	2-94
	Adjust/Maintenance (Adjust/Maintenance selection/setting)	2-97
<b>3</b>	<b>Options</b>	
	General Information .....	3-2
	Expansion Memory Modules .....	3-3
	General Description of Options .....	3-5
<b>4</b>	<b>Computer Interface</b>	
	Interface .....	4-2
	USB Interface .....	4-2
	Network Interface .....	4-3

**Glossary**

**Index**



# INTRODUCTION

---

This guide has the following chapters:

***1 Handling Paper***

Explains how choose, handle and load paper.

***2 Using the Operation Panel***

Explains how to use the operation panel to configure the printer.

***3 Options***

Shows the available options.

***4 Computer Interface***

Describes the possible connections between the printer and your computer.

***Glossary***

A Glossary of terms used is provided here.

---

## Conventions

This manual uses the following conventions:

Convention	Description	Example
<b>Italic Typeface</b>	Used to emphasize a key word, phrase or reference to additional information.	To replace the toner container, refer to <i>Toner Container Replacement on page 3-2</i> .
<b>Bold</b>	Used to denote buttons on the software.	To start printing, click <b>OK</b> .
<b>Bracket Bold</b>	Used to denote operation panel keys.	Press <b>[GO]</b> to resume printing.
<b>Note</b>	Used to provide additional or useful information about a function or feature.	 <b>Note</b> Check with your network administrator for the network address settings.
<b>Important</b>	Used to provide important information.	<b>IMPORTANT</b> Ensure paper is not folded, curled, or damaged.
<b>Caution</b>	Cautions are statements that suggest <i>mechanical</i> damage as a result of an action.	<b>CAUTION</b> Components inside the fuser cover are hot. Do not touch it with your hands as it may result in burn injury.
<b>Warning</b>	Used to alert users to the possibility of <i>personal</i> injury.	<b>WARNING</b> High voltage is present in the charger section.

# 1 Handling Paper

---

This chapter contains explanations on the following topics:

<b>General Guidelines</b>	<b>1-2</b>
<b>Selecting the Right Paper</b>	<b>1-4</b>
<b>Paper Type</b>	<b>1-13</b>
<b>Loading Paper</b>	<b>1-14</b>



---

## General Guidelines

The machine is designed to print on standard copier paper (the type used in ordinary dry copier machines), but it can also accept a variety of other types of paper within the limits specified below.



**Note** The manufacturer assumes no liability for problems that occur when paper not satisfying these requirements is used.

Selection of the right paper is important. Using the wrong paper can result in paper jams, curling, poor print quality, and paper waste, and in extreme cases can damage the machine. The guidelines given below will increase the productivity of your office by ensuring efficient, trouble-free printing and reducing wear and tear on the machine.

### Paper Availability

Most types of paper are compatible with a variety of machines. Paper intended for xerographic copiers can also be used with the machine.

There are three general grades of paper: *economy*, *standard*, and *premium*. The most significant difference between grades is the ease with which they pass through the machine. This is affected by the *smoothness*, *size*, and *moisture content* of the paper, and the way in which the paper is cut. The higher the grade of paper you use, the less risk there will be of paper jams and other problems, and the higher the level of quality your printed output will reflect.

Differences between paper from different suppliers can also affect the machine's performance. A high-quality printer cannot produce high-quality results when the wrong paper is used. Low-priced paper is not economical in the long run if it causes printing problems.

Paper in each grade is available in a range of basis weights (defined later). The traditional standard weights are 60 to 120 g/m<sup>2</sup> (16 to 32 pounds).

### Paper Specifications

The following table summarizes the basic paper specifications. Details are given on the following pages.

Item	Specification
<b>Weight</b>	Cassette, PF-500 (optional): 60 to 120 g/m <sup>2</sup> (16 to 32 lb/ream) MP Tray, PF-510 (optional): 60 to 220 g/m <sup>2</sup> (16 to 59 lb/ream)
<b>Thickness</b>	0.086 to 0.110 mm (3.4 to 4.3 mils)
<b>Dimensions</b>	Refer to <i>Paper Sizes on page 1-4</i>
<b>Dimensional accuracy</b>	±0.7 mm (±0.0276 inches)
<b>Squareness of corners</b>	90° ±0.2°
<b>Moisture content</b>	4 % to 6 %
<b>Direction of grain</b>	Long grain
<b>Pulp content</b>	80 % or more

## Minimum and Maximum Paper Sizes

The minimum and maximum paper sizes are as follows. For non standard paper such as transparency, labels, vellum, cardstock, envelope, and coated, the MP (Multi-Purpose) tray must be used.

Paper Cassette

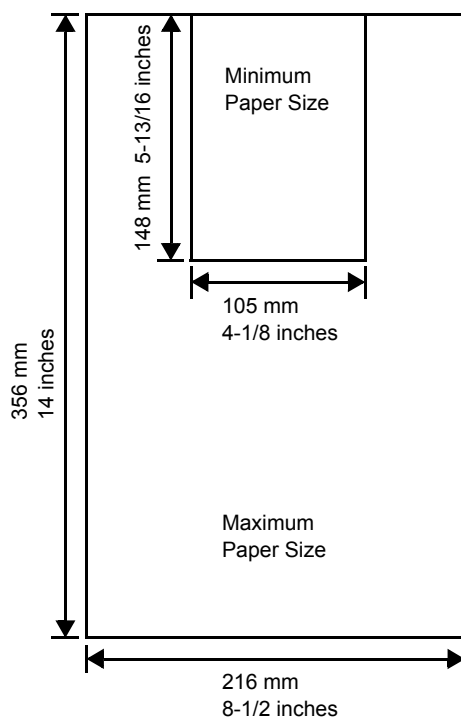

MP Tray

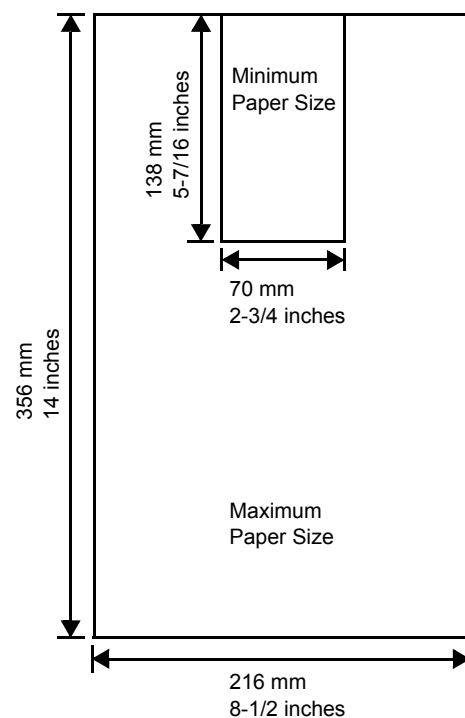

## Recommended Paper

The following products are recommended for use with the printer for optimum performance.

Size	Product	Weight
Letter, Legal	International Paper Hammermill Tidal MP	75 g/m <sup>2</sup> (20 lb)
A4	Nautilus ReFresh TRIOTEC	80 g/m <sup>2</sup>

## Selecting the Right Paper

This section describes the guidelines for selecting paper.

### Condition

Avoid using paper that is bent at the edges, curled, dirty, torn, embossed, or contaminated with lint, clay, or paper shreds.

Use of paper in these conditions can lead to illegible printing and paper jams, and can shorten the life of the machine. In particular, avoid using paper with a surface coating or other surface treatment. Paper should have as smooth and even a surface as possible.

### Composition

Do not use paper that has been coated or surface-treated and contains plastic or carbon. The heat of fusing can cause such paper to give off harmful fumes.

Bond paper should contain at least 80 % pulp. Not more than 20 % of the total paper content should consist of cotton or other fibers.

### Paper Sizes

*Cassettes* and the *MP tray* are available for the paper sizes listed in the table below. For details, including the paper sizes for the paper feeder (Optional paper feeder PF-500, PF-510) refer to *Cassette (1 to 4) Size (Setting the cassette paper size) on page 2-31*.

The dimensional tolerances are  $\pm 0.7$  mm ( $\pm 0.0276$  inches) for the length and width. The angle at the corners must be  $90^\circ \pm 0.2^\circ$ .

MP Tray Only	Size	Cassette or MP Tray	Size
Env. Monarch	3-7/8 × 7-1/2 inches	Legal	8-1/2 × 14 inches
Envelope #10	4-1/8 × 9-1/2 inches	Letter	8-1/2 × 11 inches
Envelope #9	3-7/8 × 8-7/8 inches	ISO A4	210 × 297 mm
Envelope #6	3-5/8 × 6-1/2 inches	ISO A5	148 × 210 mm
Envelope DL	110 × 220 mm	ISO A6	105 × 148 mm
JIS B6	128 × 182 mm	Envelope C5	162 × 229 mm
Hagaki	100 × 148 mm	ISO B5	176 × 250 mm
OufukuHagaki	148 × 200 mm	JIS B5	182 × 257 mm
Youkei 2	114 × 162 mm	Statement	5-1/2 × 8-1/2 inches
Youkei 4	105 × 235 mm	Executive	7-1/4 × 10-1/2 inches
		Oficio II	8-1/2 × 13 inches
		Folio	210 × 330 mm
		16 kai	197 × 273 mm
		216 × 340 mm	216 × 340 mm
Custom	Cassette: 105 to 216 mm × 148 to 356 mm (4-1/8 to 8-1/2 inches × 5-13/16 to 14 inches) MP Tray: 70 to 216 mm × 138 to 356 mm (2-3/4 to 8-1/2 inches × 5-7/16 to 14 inches)		

---

## Smoothness

The paper should have a smooth, uncoated surface. Paper with a rough or sandy surface can cause voids in the printed output. Paper that is too smooth can cause multiple feeding and fogging problems. (Fogging is a gray background effect.)

## Basis Weight

Basis weight is the weight of paper expressed in grams per square meter ( $\text{g/m}^2$ ). Paper that is too heavy or too light may cause feed errors or paper jams as well as premature wear of the product. Uneven weight of paper, namely uneven paper thickness may cause multiple-sheet feeding or print quality problems such as blurring because of poor toner fusing.

The recommended basis weight is:

Cassette: 60 to 120  $\text{g/m}^2$

MP tray: 60 to 220  $\text{g/m}^2$

PF-500 (optional): 60 to 120  $\text{g/m}^2$

PF-510 (optional): 60 to 220  $\text{g/m}^2$

## Paper Weight Equivalence Table

The paper weight is listed in pounds (lb) and metric grams per square meter ( $\text{g/m}^2$ ). The shaded part indicates the standard weight.

U. S. Bond Weight (lb)	Europe Metric Weight ( $\text{g/m}^2$ )
16	60
17	64
20	75
21	80
22	81
24	90
27	100
28	105
32	120
34	128
36	135
39	148
42	157
43	163
47	176
53	199

---

## Thickness

The paper used with the machine should be neither extremely thick nor extremely thin. If you are having problems with paper jams, multiple feeds, and faint printing, the paper you are using may be too thin. If you are having problems with paper jams and blurred printing the paper may be too thick. The correct thickness is 0.086 to 0.110 mm (3.4 to 4.3 mils).

## Moisture Content

Moisture content is defined as the percent ratio of moisture to the dry mass of the paper. Moisture can affect the paper's appearance, feed ability, curl, electrostatic properties, and toner fusing characteristics.

The moisture content of the paper varies with the relative humidity in the room. When the relative humidity is high and the paper absorbs moisture, the paper edges expand, becoming wavy in appearance. When the relative humidity is low and the paper loses moisture, the edges shrink and tighten, and print contrast may suffer.

Wavy or tight edges can cause jams and alignment anomalies. The moisture content of the paper should be 4 to 6 %.

To ensure correct moisture content, it is important to store the paper in a controlled environment. Some tips on moisture control are:

- Store paper in a cool, dry location.
- Keep the paper in its wrapping as long as possible. Re-wrap paper that is not in use.
- Store paper in its original carton. Place a pallet etc. under the carton to separate it from the floor.
- After removing paper from storage, let it stand in the same room as the machine for 48 hours before use.
- Avoid leaving paper where it is exposed to heat, sunlight, or damp.



**Note** When using coated paper, be aware that the sheets will stick together in a very humid environment.

## Paper Grain

When paper is manufactured, it is cut into sheets with the grain running parallel to the length (long grain) or parallel to the width (short grain). Short grain paper can cause feeding problems in the machine. All paper used in the machine should be long grain.

## Other Paper Properties

**Porosity:** Indicates the density of paper fiber.

**Stiffness:** Limp paper may buckle in the machine, resulting in paper jams.

**Curl:** Most paper naturally tends to curl one way if left unpacked.

**Electrostatic discharge:** During the printing process the paper is electrostatically charged to attract the toner. The paper must be able to release this charge so that printed sheets do not cling together in the *Output Tray*.

---

**Whiteness:** The contrast of the printed page depends on the whiteness of the paper. Whiter paper provides a sharper, brighter appearance.

**Quality control:** Uneven sheet size, corners that are not square, ragged edges, welded (uncut) sheets, and crushed edges and corners can cause the machine to malfunction in various ways. A quality paper supplier should take considerable care to ensure that these problems do not occur.

**Packaging:** Paper should be packed in a sturdy carton to protect it from damage during transport. Quality paper obtained from a reputable supplier is usually correctly packaged.



**Note** You might see the printer emitting steam in the area around the top tray if you use damp paper, but it is safe to continue printing.

## Special Paper

The following types of special paper can be used:

Paper Type to be Used	Paper Type to be Selected
Thin paper (60 to 64 g/m <sup>2</sup> )	VELLUM
Thick paper (90 to 220 g/m <sup>2</sup> )	THICK
Colored paper	COLOR
Recycled paper	RECYCLED
Overhead projector transparencies	TRANSPARENCY
Postcards	CARDSTOCK
Envelopes	ENVELOPE
Label	LABELS
Coated paper	COATED

Use paper that is sold specifically for use with copiers or printers (heat-fusing type). When using transparencies, labels, thin paper, envelopes, postcards, or thick paper, feed the paper from the *MP tray*. For details, refer to *Paper Source (Selecting the paper feed source)* on page 2-37.

Since the composition and quality of special paper vary considerably, special paper is more likely than white bond paper to give trouble during printing. No liability will be assumed if moisture and so forth given off during printing on special paper causes harm to the machine or operator.



**Note** Before purchasing any type of special paper, test a sample on the machine and check that printing quality is satisfactory.

---

## Transparency

Transparencies must be able to withstand the heat of fusing during the printing process. The recommended transparency product is 3M CG3700 (Letter, A4).

The table below lists the specifications for transparency:

Item	Specification
Tolerance of heat	Must tolerate at least 190 °C (374 °F)
Thickness	0.100 to 0.110 mm (3.9 to 4.3 mils)
Material	Polyester
Dimensional accuracy	±0.7 mm (±0.0276 inches)
Squareness of corners	90° ±0.2°

To prevent printing problems, feed transparencies into the printer one sheet at a time from the *MP tray*. Always load the transparencies vertically (with the long edge towards the printer).

If the transparencies have rough edges on the back, it may cause a paper jam. Remove the rough edges, reverse the sides or feed the sheet from the opposite edge.

When unloading transparencies (e.g., for clearing jams), hold them carefully by the edges to avoid leaving fingerprints on them.

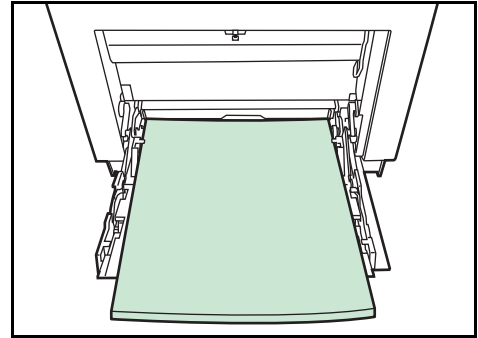

## Labels

Labels must be fed from the *MP tray* or optional paper feeder PF-510.

The basic rule for printing on adhesive labels is that the adhesive must never come into contact with any part of the machine. Adhesive paper sticking to the drum or rollers will damage the machine.

Label paper has a structure comprising of three layers, as shown in the diagram. The top sheet is printed on. The adhesive layer consists of pressure-sensitive adhesives. The carrier sheet (also called the linear or backing sheet) holds the labels until used. Due to the complexity of its composition, adhesive-backed label paper is particularly likely to give printing problems.

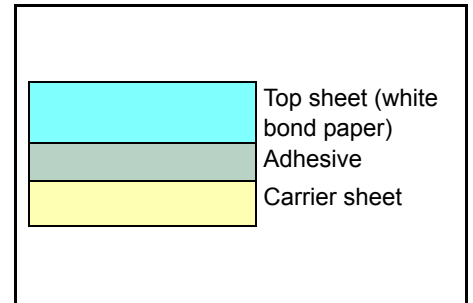

Adhesive label paper must be entirely covered by its top sheet, with no spaces between the individual labels. Labels with spaces in between are liable to peel off, causing serious paper jam problems.

Some label paper is manufactured with an extra margin of top sheet around the edge. Do not remove the extra top sheet from the carrier sheet until after printing is finished.

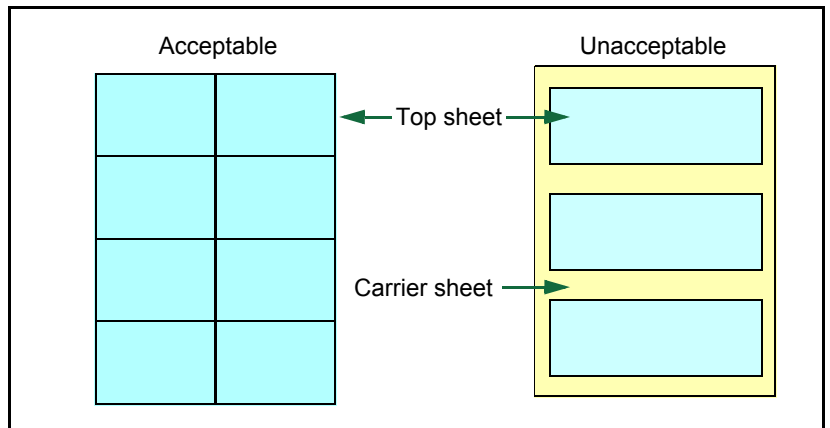

The table below lists the specifications for adhesive label paper.

Item	Specification
Weight of top sheet	44 to 74 g/m <sup>2</sup> (12 to 20 lb/ream)
Composite weight	104 to 151 g/m <sup>2</sup> (28 to 40 lb/ream)
Thickness of top sheet	0.086 to 0.107 mm (3.9 to 4.2 mils)
Composite thickness	0.115 to 0.145 mm (4.5 to 5.7 mils)
Moisture content	4 to 6 % (composite)



## Postcards

Fan the stack of postcards and align the edges before loading them in the MP tray. Make sure the postcards you are going to set are not curled. Feeding curled postcards may cause paper jams.

Some postcards have rough edges on the back (those are created when the paper is cut). In this case, put the postcards on a flat place and rub the edges with, for example, a ruler to smooth them.

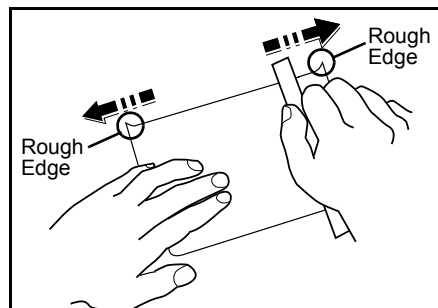

## Envelopes

Slide the envelope switch to envelope mode and print.

**IMPORTANT** Envelopes cannot be printed in paper mode. When printing plain paper while the envelope mode is selected, the printing speed and quality will lower than in paper mode.

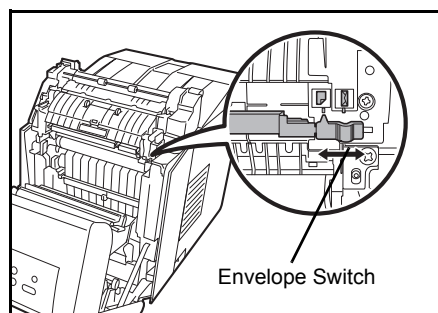

Envelopes should always be fed from the MP tray, with the print-side down. If you use envelopes quite often, we recommend to use optional paper feeder PF-510.

Since the composition of an envelope is more complex than that of ordinary paper, it is not always possible to ensure consistent printing quality over the entire envelope surface.

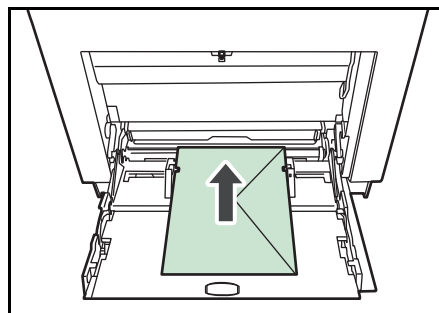

Normally, envelopes have a diagonal grain direction. Refer to *Paper Grain* on page 1-6. This direction can easily cause wrinkles and creases when envelopes pass through the printer. Before purchasing envelopes, make a test print to check whether the printer accepts the envelope.

- Do not use envelopes that have an encapsulated liquid adhesive.
- Avoid a long printing session for envelopes only. Extended envelope printing can cause premature printer wear.
- If jams occur, try setting a lesser number of envelopes on the MP tray.
- To avoid jams caused by curled envelopes, stack no more than 10 printed envelopes on the top tray.

---

## Thick Paper

Fan the stack of paper and align the edges before loading them. Some types of paper have rough edges on the back (those are created when the paper is cut). In this case, put the paper on a flat place and rub the edges once or twice with, for example, a ruler to smooth them. Feeding rough edged paper may cause paper jams.



**Note** If the paper jams even after you smooth it out, load the paper in the *MP tray* with the leading edge raised up a few millimeters as shown in the illustration.

If you use thick paper quite often, we recommend to use optional paper feeder PF-510.

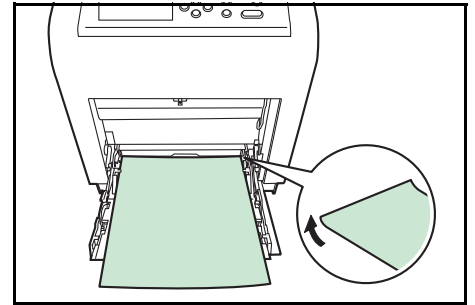

## Colored Paper

Colored paper should satisfy the same conditions as white bond paper, refer to *Paper Specifications on page 1-2*. In addition, the pigments used in the paper must be able to withstand the heat of fusing during the printing process (up to 200 °C or 392 °F).



**Note** If you use colored paper quite often, we recommend to use optional paper feeder PF-510.

## Preprinted Paper

Preprinted paper should satisfy the same conditions as white bond paper, refer to *Paper Specifications on page 1-2*. The preprinted ink must be able to withstand the heat of fusing during the printing process, and must not be affected by silicone oil. Do not use paper with any kind of surface treatment, such as the type of paper commonly used for calendars.

## Recycled Paper

Select recycled paper that meets the same specifications as the white bond paper except for whiteness, refer to *Paper Specifications on page 1-2*.



**Note** Before purchasing recycled paper, test a sample on the machine and check that the printing quality is satisfactory.

## Coated Paper

Coated paper is created by treating the surface of the base paper with a coating that provides higher printing quality than plain paper. Coated paper is used for particularly high quality printing.

The surface of high-quality or medium-quality paper is coated with special agents that improve ink adhesion by making the paper surface smoother. These agents are used either to coat both sides of the paper or just one side. The coated side appears slightly glossy.

---

**IMPORTANT** When printing on coated paper in very humid environments, ensure that the paper is kept dry as moisture may cause sheets to stick together when they are fed into the printer.

### Paper Type Indicators (Optional paper feeder PF-510)

If you are going to load non standard paper in the optional paper feeder PF-510, cut out the blank section of the attached paper type indicator sheet, fold the remaining sheet in half and insert it into the cassette's display folder so that the paper type symbol is displayed.

-  Envelopes
-  Thick paper
-  Labels
-  Coated paper

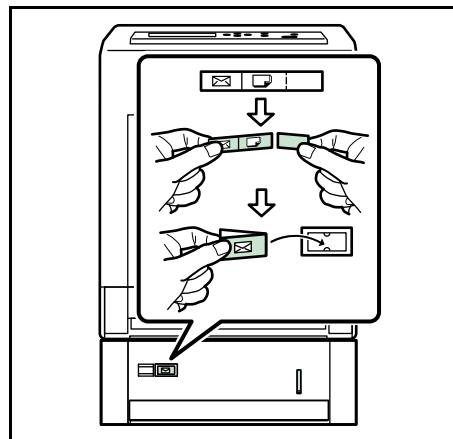

## Paper Type

The printer is capable of printing under the optimum setting for the type of paper being used.

Setting the paper type for the paper source from the printer's operation panel will cause the printer to automatically select the paper source and print in the mode best suited to that type of paper.

A different paper type setting can be made for each paper source including the MP tray. Not only can preset paper types be selected, but it is also possible for you to define and select customized paper types. Refer to *Type Adjust (Creating custom paper type)* on page 2-34. The following types of paper can be used.

Paper Type	Paper Source				
	MP Tray	Paper Cassette Optional Paper Feeder PF-500	Paper Weight	Duplex Path	Optional Paper Feeder PF-510
PLAIN	Yes	Yes	Normal 2	Yes	Yes
TRANSPARENCY	Yes	No	Extra Heavy	No	No
PREPRINTED	Yes	Yes	Normal 2	Yes	Yes
LABELS	Yes	No	Heavy 1	No	Yes
BOND	Yes	Yes	Normal 3	Yes	Yes
RECYCLED	Yes	Yes	Normal 2	Yes	Yes
VELLUM	Yes	No	Light	No	No
ROUGH	Yes	Yes	Normal 3	Yes	Yes
LETTERHEAD	Yes	Yes	Normal 2	Yes	Yes
COLOR	Yes	Yes	Normal 2	Yes	Yes
PREPUNCHED	Yes	Yes	Normal 2	Yes	Yes
ENVELOPE	Yes	No	Heavy 2	No	Yes
CARDSTOCK	Yes	No	Heavy 1	No	Yes
COATED	Yes	No	Heavy 1	Yes	Yes
THICK	Yes	No	Heavy 2	No	Yes
HIGH QUALITY	Yes	Yes	Normal 3	Yes	Yes
CUSTOM 1 (to 8) <sup>†</sup>	Yes	Yes	Normal 2	Yes	Yes

Yes: Can be stored No: Cannot be stored

†. This is a paper type defined and registered by the user. Up to eight types of user settings may be defined. For details, refer to *Type Adjust (Creating custom paper type)* on page 2-34.

---

## Loading Paper

The following explains the procedure for loading paper in the cassette and the MP tray.

### Loading Paper into the Cassette

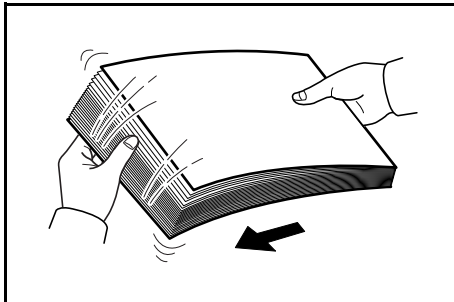

- 1 Fan the media (paper/transparencies), then tap it on a level surface to avoid media jams or skewed printing.

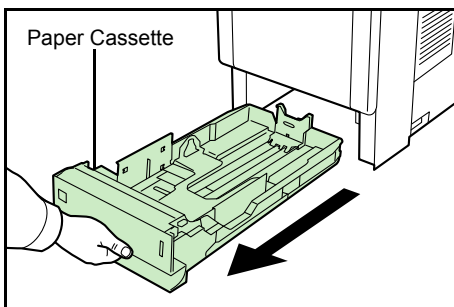
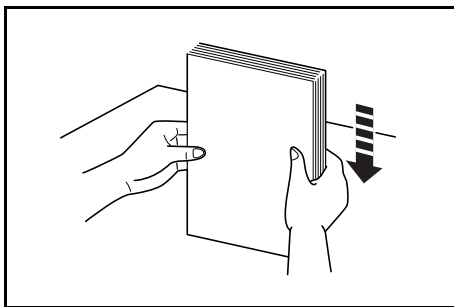

- 2 Pull the paper cassette all the way out of the printer.

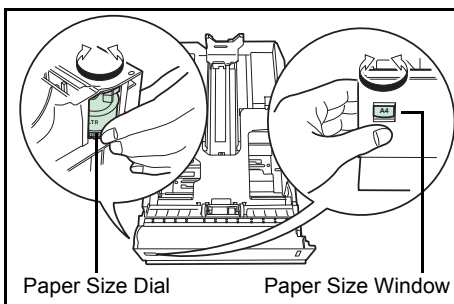

- 3 Turn the paper size dial so that the size of the paper you are going to use appears in the paper size window.



**Note** When the paper size dial is set to **Other** the paper size must be set into the printer on the operation panel. Refer to *Cassette (1 to 4) Size (Setting the cassette paper size)* on page 2-31.

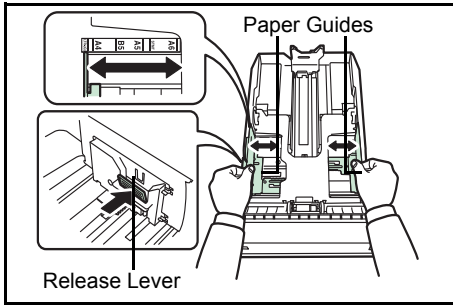

- 4 Pull the release lever of both side guides and slide to the desired paper size.

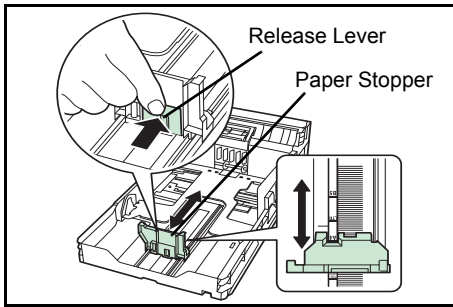

- 5 Pull the release lever and slide the paper stopper to the desired paper size.

When using non-standard size paper, move the paper guides and paper stopper all the way out, insert the paper, then adjust the paper guides and paper stopper to the size of the paper. Adjust them so that they are in light contact with the paper.

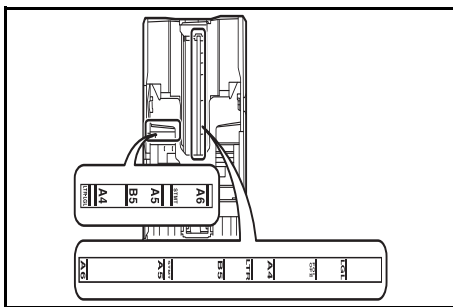

Standard paper sizes are marked on the inside of the paper cassette.

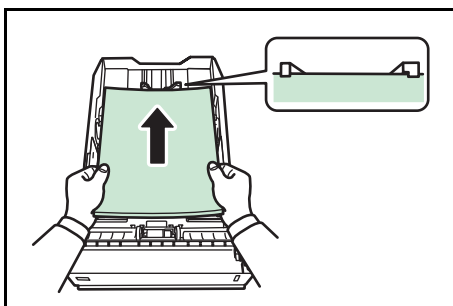

- 6 Slide the paper into the paper cassette.

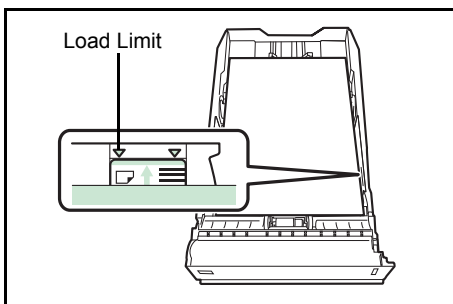

**Note** Do not load more paper than will fit under the load limits on the paper guides.

The paper cassette will hold approximately 500 sheets of 80 g/m<sup>2</sup> (21 lb.) paper with a thickness of 0.11 mm.

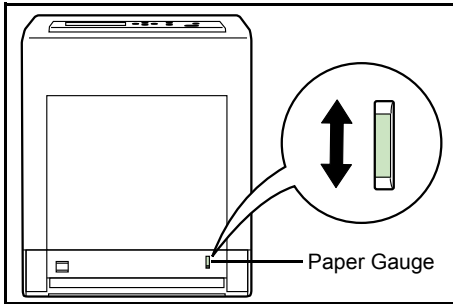

**7** Insert the paper cassette into the slot in the printer. Push it straight in as far as it will go.

There is a paper gauge on the right side of the front of the paper cassette to indicate the remaining paper supply. When paper is exhausted, the pointer will go down to the level of  (empty).

### Loading Paper into the MP (Multi-Purpose) Tray

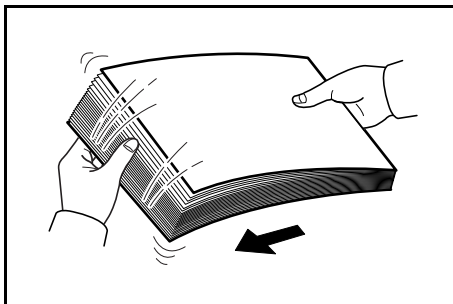

**1** Fan the media (paper/transparencies), then tap it on a level surface to avoid media jams or skewed printing.

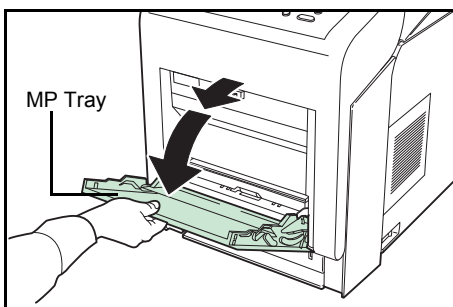
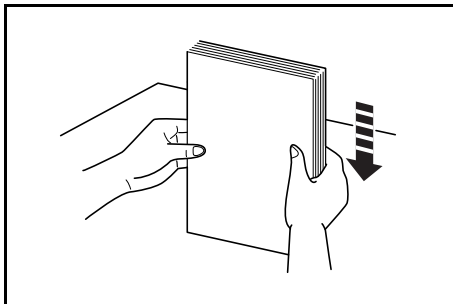

**2** Press the center of the MP tray, and pull it towards you until it stops.

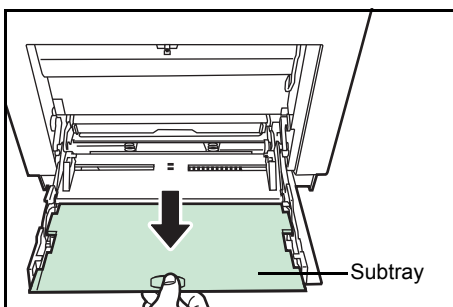

**3** Pull the subtray toward you until it stops, making sure there are no gaps.

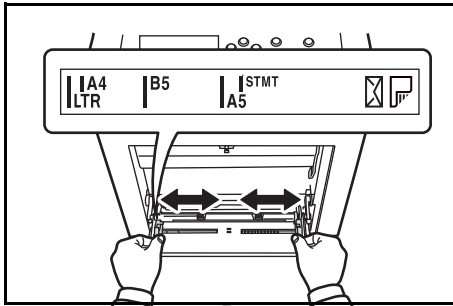

- 4 Adjust the position of the paper guides on the MP tray. Standard paper sizes are marked on the MP tray. For standard paper sizes, slide the guides to the position marked correspondingly.

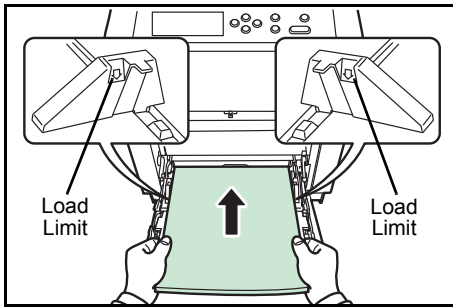

- 5 Align the paper with the paper guides and insert as far as it will go.



**Note** Do not load more paper than will fit under the load limits on the inside of the MP tray.

When printing on transparencies, feed the sheets into the printer one at a time.

If the paper is considerably curled in one direction, for example, if the paper is already printed on one side, try to roll the paper in the opposite direction to counteract the curl. Printed sheets will then come out flat.

<b>Correct</b>		
<b>Incorrect</b>		

- 6 Set the MP tray paper size on the printer's operation panel. Refer to *MP Tray Size (Setting MP tray paper size)* on page 2-29.

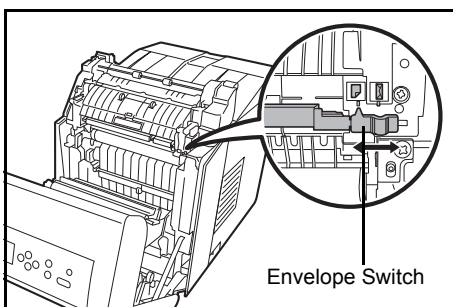

- 7 Set the appropriate print mode for the paper thickness (envelopes or plain paper). To print on envelopes, slide the envelope switch to the right to select envelope mode. To print on plain paper, slide the switch to the left to select paper mode.

The print modes are imprinted on the switch. Check that the correct mode is selected for the paper being used.

**IMPORTANT** Envelopes cannot be printed in paper mode. When printing plain paper while the envelope mode is selected, the printing speed and quality will lower than in paper mode.



---

## Paper stopper

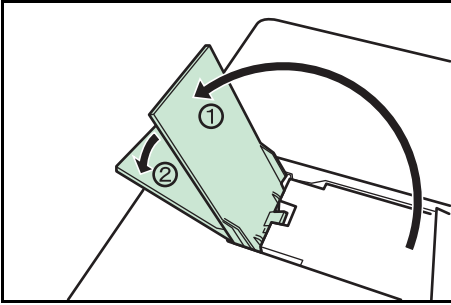

Align the paper stopper to the desired paper size.

- For A4 or Letter size paper : Align with position ①.
- For Legal size paper : Align with position ②.

## 2 Using the Operation Panel

---

This chapter contains explanations on the following topics:

<b>General Information</b>	<b>2-2</b>
<b>Understanding the Operation Panel</b>	<b>2-3</b>
<b>Keys</b>	<b>2-6</b>
<b>Using the Menu Selection System</b>	<b>2-8</b>
<b>Setting a Mode Selection Menu</b>	<b>2-10</b>
<b>Report Print</b>	<b>2-11</b>
<b>USB Memory (USB memory selection)</b>	<b>2-16</b>
<b>Custom Box (Using a Custom Box)</b>	<b>2-18</b>
<b>Job Box</b>	<b>2-22</b>
<b>Counter (Viewing the counter value)</b>	<b>2-28</b>
<b>Paper Settings</b>	<b>2-29</b>
<b>Print Settings</b>	<b>2-37</b>
<b>Network (Network settings)</b>	<b>2-47</b>
<b>Optional Network (Optional Network settings)</b>	<b>2-56</b>
<b>Device Common (Selecting/Setting the common device)</b>	<b>2-61</b>
<b>Security</b>	<b>2-79</b>
<b>Job Accounting (Job Accounting selection/setting)</b>	<b>2-87</b>
<b>Administrator (Administrator settings)</b>	<b>2-94</b>
<b>Adjust/Maintenance (Adjust/Maintenance selection/setting)</b>	<b>2-97</b>

---

## General Information

This chapter provides the information you need to configure the Ecosys Color printer. In general you need to use the operation panel only to make default settings. You can make most changes to the printer settings using the printer driver through the application software.



**Note** Changes to printer settings made using a software application override changes made using the operation panel.

You can also access the printer's various settings from a remote location, by using the control panel, the printer driver or other utilities such as the Status Monitor Utility. Other printer utilities can be installed using the DVD-ROM supplied with the printer.

The chapter describes the operation panel in detail, including its menus and the procedures for changing various printer settings.

---

## Understanding the Operation Panel

The operation panel on the top of the printer has a 2-line by 21-character liquid crystal display (LCD), eight keys, and three indicators (LED).

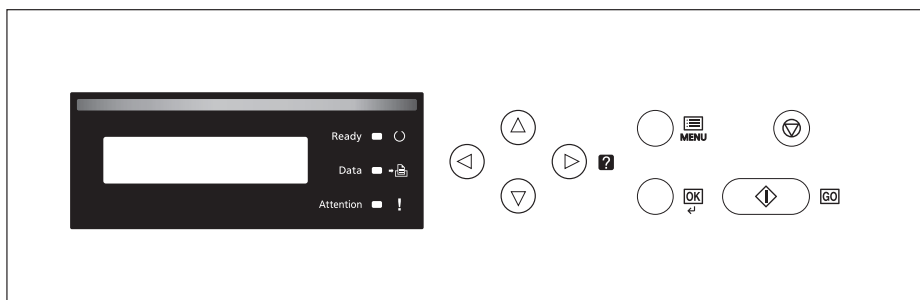

Messages that appear on the display and functions of indicators and keys are explained in this chapter.

### Message Display

The message display on the operation panel shows:

- Status information, the ten messages listed below which are displayed during normal operation.
- Error codes, when the printer requires the operator's attention; as explained in the *Operation Guide*.

---

## Status Information

Message	Meaning
Self test	The printer is performing self-diagnostics after power-up.
Please wait	The printer is warming up and is not ready. When the printer is switched on for the first time, this message will take several minutes.
Please wait (Paper loading)	This message appears when the printer is preparing to print coated paper (COATED) fed from the optional paper feeder PF-510.
Please wait (Adding toner)	Toner is currently being replenished. This message may be displayed during continuous printing of a large volume of pages which require a large amount of toner such as with photographs, etc.
Please wait (Calibrating)	The color calibration function is being performed automatically as you powered on the printer. You can also execute this function manually on the operation panel. For details, refer to <i>Color Calibration on page 2-97</i> .
Please wait (Cleaning)	Displayed during LSU cleaning mode.
Please wait (Cooling)	The printer is being cooled down and is not ready.
Ready	The printer is ready to print.
Processing	The printer is receiving data to print. This is also shown when the printer is reading a USB memory, SSD or RAM disk.
Low Power	The printer is in Low Power Mode. The printer wakes from Low Power Mode whenever a print job is received. The printer then warms up and goes on-line. For details on Low Power Mode, refer to <i>Low Power Timer (Low Power Mode timer timeout time) on page 2-71</i> .
Sleeping	The printer is in Auto Sleep. The printer wakes from Auto Sleep whenever a print job is received. The printer then warms up and goes on-line. For details on Auto Sleep, refer to <i>Sleep Timer (Sleep timer timeout time) on page 2-71</i> .
Canceling data	Jobs inside the printer are being canceled. To cancel a job, refer to <i>Canceling a Printing Job on page 2-6</i> .

## Error Codes





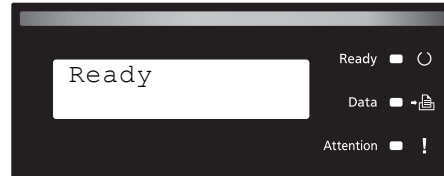

Refer to the *Troubleshooting* section in the *Operation Guide*.

## Indicators in Message Display



### Ready, Data, and Attention Indicators

The following indicators light during normal operation and whenever the printer needs attention. Depending on the status of lighting, each indicator has the following meaning:

Indicator	Description
<b>Ready</b>  	<p><b>Flashing.</b> Indicates an error that you can resolve. For details, refer to the <i>Troubleshooting</i> section in the <i>Operation Guide</i>.</p> <p><b>On.</b> Indicates that the printer is ready and on-line. The printer prints the data it receives.</p> <p><b>Off.</b> Indicates that the printer is off-line. Data can be received but will not be printed. Also, indicates when printing is automatically stopped due to an error condition. For details, refer to the <i>Troubleshooting</i> section in the <i>Operation Guide</i>.</p>
<b>Data</b>  	<p><b>Flashing.</b> Indicates that a data is being received.</p> <p><b>On.</b> Indicates either that data received is being processed before printing starts, or that data is being written to or read from a SSD.</p>
<b>Attention</b>  	<p><b>Flashing.</b> Indicates that the printer requires maintenance or is warming up.</p> <p><b>On.</b> Indicates the occurrence of a problem or an error. For details, refer to the <i>Troubleshooting</i> section in the <i>Operation Guide</i>.</p>

---

## Keys

The operation panel keys are used to configure the printer operation. Note that certain keys have a secondary function.

### GO Key



Use this key to:

- Toggle the printer's on-line and off-line states. You can temporarily stop the print job by switching the printer off-line.
- Print and feed out one page when the printer displays *Waiting*.
- Recover from certain errors.
- Recover from Auto Sleep.

### Cancel Key



This key is used to:

- Cancel a printing job.
- Stop the alarm sound.
- Reset numeric values or cancel a setting procedure while using menu system.

### Canceling a Printing Job

- 1** While the printer displays *Processing*, press **[Cancel]**.

*Print Cancel?* appears on the message display followed by the job name currently in progress.

- 2** Press  $\Delta$  or  $\nabla$  to display the desired job and **[OK]**.

*Canceling data* appears on the message display and printing stops after the current page is printed.

### MENU Key



- **[MENU]** lets you enter the menu system to change the setup and printing environment of the printer.

### Arrow Keys

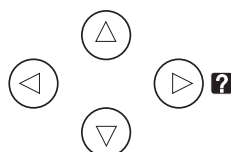

- The four arrow keys are used in the menu system to access an item or enter numeric values. Use  $\Delta$  and  $\nabla$  to change menus, and  $\triangleleft$  and  $\triangleright$  to move to the sub menu.
- The arrow key with the question mark (**?**) may be pressed when the paper jam message has appeared on the message display. A help message will then appear to facilitate jam clearing in the location.

- 
- When `Use alternative?` is shown in the message display, use  $\Delta$  and  $\nabla$  key to select an alternative paper source.

### OK Key



This key is used to:

- Finalize settings of numeric values and other selections.
- Set the paper source when `Use alternative?` is shown in the message display.



## Using the Menu Selection System

### Menu Selection System

This section explains how to use the menu selection system.

**[MENU]** on the operation panel allows you to use the menu to configure the printer settings to your specific needs. Settings can be made when *Ready* is indicated on the printer message display.



**Note** Settings that are received from application software and the printer driver will take priority over settings made in the operation panel.

### Entering the Mode Selection Menu

Press **[MENU]** when *Ready* is indicated on the printer message display. The mode selection menu is displayed.

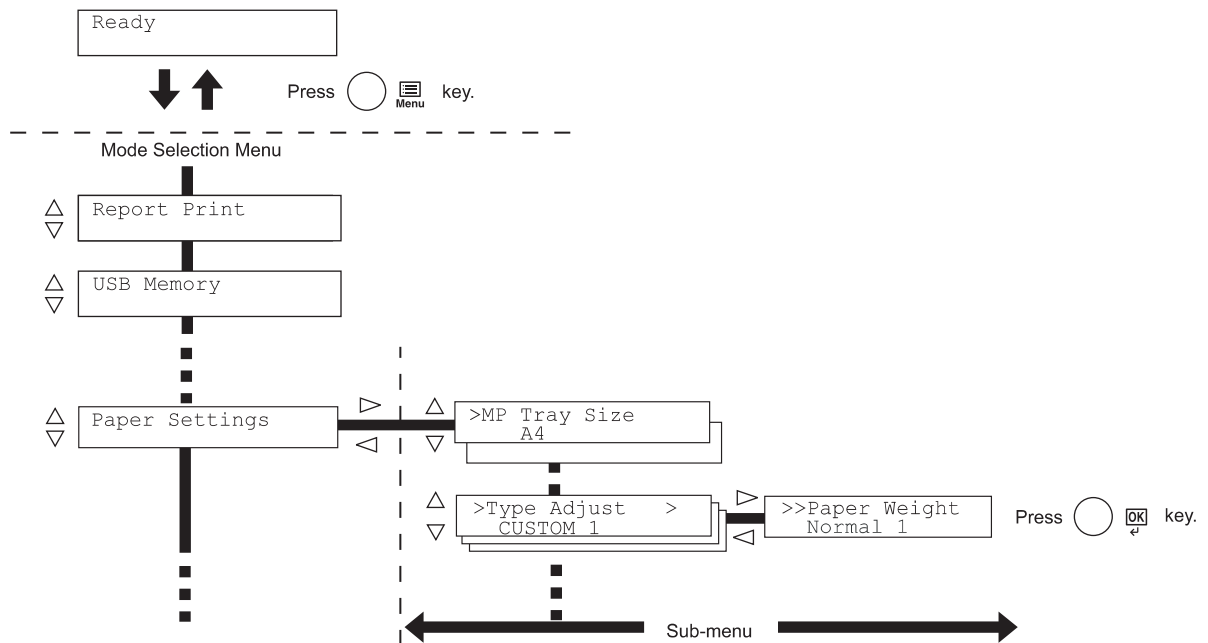

**IMPORTANT** The *Custom Box* option appears in the mode selection menu when the SSD is installed. The *Job Box* option appears when the SSD is installed or the RAM disk has been set up. For more information, please refer to *Custom Box (Using a Custom Box)* on page 2-18, *Job Box* on page 2-22 or *RAM Disk Mode (Using the RAM disk)* on page 2-66.

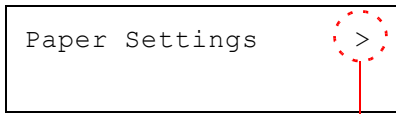

Indicates that there is a sub-menu

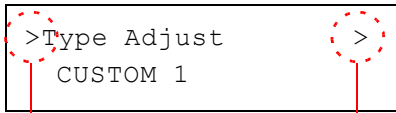

Indicates that this is the sub-menu

Indicates that there is another sub-menu

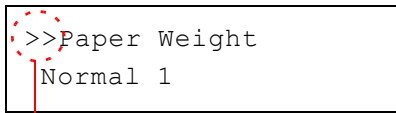

Indicates that this is the second sub-menu

## Selecting a Menu

The mode selection menu is hierarchical. Press  $\triangle$  or  $\nabla$  to display the desired menu.

If the selected menu has a sub-menu, > is displayed after the menu.

Press  $\triangleright$  to move to the sub-menu or  $\triangleleft$  to go back.

> is displayed before the sub-menu.

Press  $\triangleright$  to move to another sub-menu or  $\triangleleft$  to go back.

>> is displayed before the second sub-menu.

## Setting a Menu

Select the desired menu and press **[OK]** to set or change the configuration.

Press  $\triangle$  or  $\nabla$  to display the desired item and **[OK]** to finalize the value or selections set.

## Cancelling Menu Selection

If you press **[MENU]** when a menu is selected, the message display returns to *Ready*.

---

## Setting a Mode Selection Menu

This section explains the setting procedures used for each menu item in the mode selection menu.

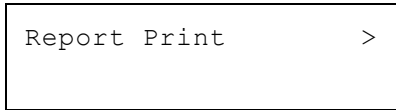

**1** While the printer displays *Ready, Please wait, Sleeping and Processing*, press **[MENU]**. The mode selection menu is displayed. (For example :*Report Print*)

**2** Each time you press  $\Delta$  or  $\nabla$ , the selection changes.

- Report Print
- USB Memory
- Custom Box
- Job Box
- Counter
- Paper Settings
- Print Settings
- Network
- Optional Network
- Device Common
- Security
- Job Accounting
- Administrator
- Adjust/Maintenance



**Note** If you use the mode first selected when the printer is turned on, *Report Print* is displayed. For the second and subsequent times, the last menu option you selected the previous time is displayed.

---

## Report Print

The printer prints the report. Report Print includes the following items:

- Print Menu Map
- Print Status Page
- Print Fonts List
- Print RAM Disk File List
- Print SSD File List

**1** Press **[MENU]**.

**2** Press  $\Delta$  or  $\nabla$  repeatedly until `Report Print >` appears.

```
Report Print >
```

Note that menus shown in the list may vary depending on which optional units installed in the printer.

## Print Menu Map

The printer prints a full list of the menu selection system menu map.

**1** Press  $\triangleright$  while `Report Print >` is displayed.

**2** `>Print Menu Map` appears. In other displays, press  $\Delta$  or  $\nabla$  repeatedly until the map appears.

**3** Press **[OK]**. A question mark (?) appears.

```
>Print Menu Map ?
```

**4** Press **[OK]**. The message `Processing` appears and the printer prints a Menu Map.

Menu Map Sample

# Menu Map

Printer

**Firmware version** .....

---

===== .....	.....	.....	.....
.....	.....	.....	.....
.....	.....	.....	.....
.....	.....	.....	.....
.....	.....	.....	.....
.....	.....	.....	.....
.....	.....	.....	.....
.....	.....	.....	.....
.....	.....	.....	.....
.....	.....	.....	.....
.....	.....	.....	.....
.....	.....	.....	.....
.....	.....	.....	.....
.....	.....	.....	.....
.....	.....	.....	.....
.....	.....	.....	.....
.....	.....	.....	.....
.....	.....	.....	.....
.....	.....	.....	.....

---

.....

## Print Status Page

You can check the printer's current status, including available memory space and option settings by printing a status page.

- 1 Press  $\triangleright$  while `Report Print >` is displayed.
- 2 Press  $\triangle$  or  $\nabla$  repeatedly until `>Print Status Page` appears.
- 3 Press **[OK]**. A question mark (?) appears.

>Print Status Page ?

- 4 Press **[OK]** again. The message `Processing` appears and the printer prints a status page.

For a sample status page and its full description, refer to the next section *Understanding the Status Page*.

## Understanding the Status Page

The numbers in the following diagram refer the items explained below the diagram. The items and values on the status page may vary depending on the printer's firmware version.

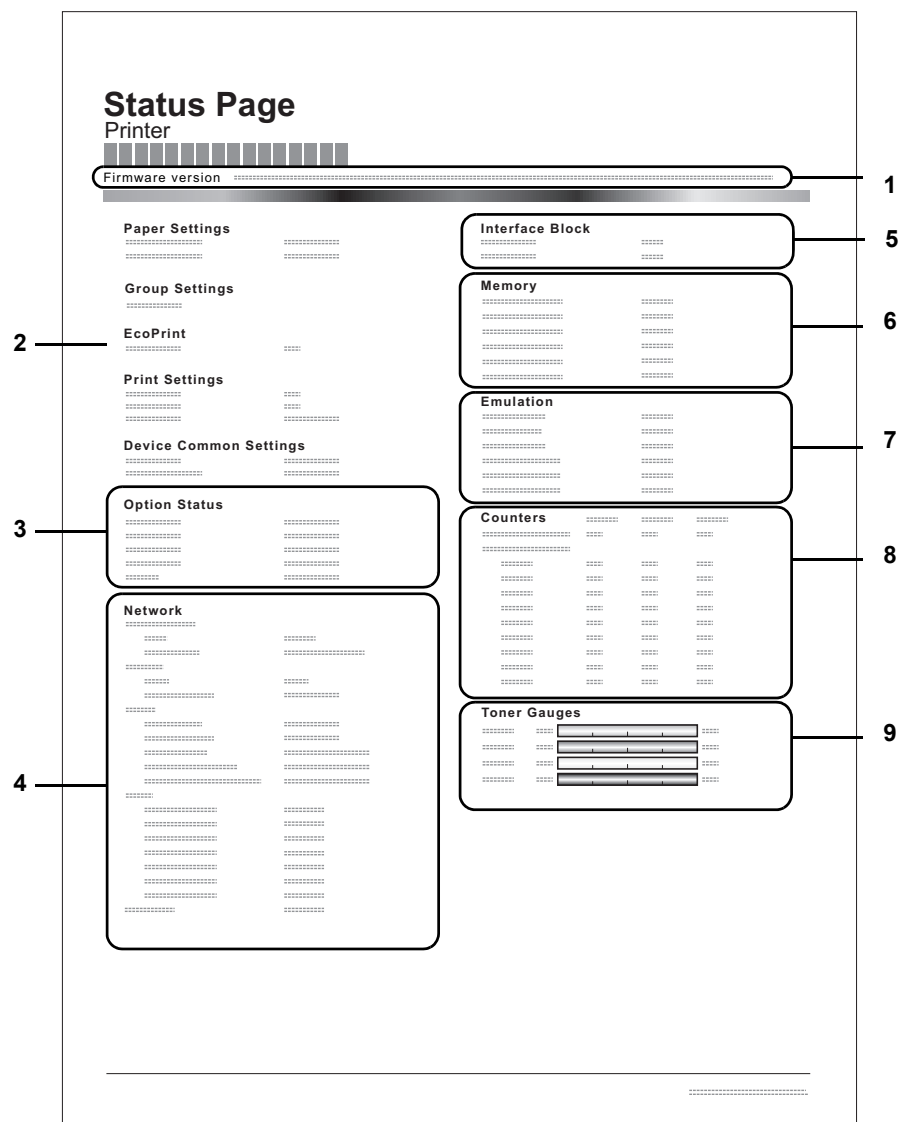

---

## **1 Firmware Version**

This item shows the version and release date of the printer firmware.

## **2 Printer Settings Information**

This item shows various printer settings for hardware-related items:

- Paper Settings
- Group Settings
- Print Settings
- EcoPrint
- Device Common Settings

## **3 Installed Options**

This item shows the options installed in the printer:

- Paper Feeder
- SSD

## **4 Network Status**

This item shows the IP address, subnet mask address, and default gateway address for the network interface card in the printer.

## **5 Interface Information**

This information shows the block status for items including the USB memory slot, USB interface and option interface.

## **6 Memory**

This item shows:

- Standard memory in the printer
- Option memory slot status in megabytes
- Total memory in the printer
- Current status of the RAM disk

## **7 Emulation**

This item shows all available emulations of the printer. The KPDL (AUTO) emulation is set as default when the printer is shipped from the factory. The emulations are:

- PCL 6
- KPDL
- KPDL (AUTO)

## **8 Page Information**

This item shows the page related items:

- Total printed page count
- Total page count of each paper size

## **9 Consumable Status**

This item shows the approximate level of remaining toner. When the value is 100, the toner container is full. The closer to 0, the smaller the amount of remaining toner.

---

### Print Fonts List

To help you decide in selecting a font, you can printout lists of the internal fonts or the optional fonts.

- 1 Press  $\triangleright$  while `Report Print >` is displayed.
- 2 Press  $\triangle$  or  $\nabla$  repeatedly until `>Print Fonts List` appears.
- 3 Press **[OK]**. A question mark (?) appears.

```
>Print Fonts List ?
```

- 4 Press **[OK]** again. The message `Processing` appears and the printer prints a list of fonts with a sample and font ID (number) for each of them.

### Print RAM Disk File List

This allows you to print a list of the files on the RAM disk.

**IMPORTANT** This is displayed when RAM disk mode is enabled.

- 1 Press  $\triangleright$  while `Report Print >` is displayed.
- 2 Press  $\triangle$  or  $\nabla$  repeatedly until `>Print RAM Disk File List` appears.
- 3 Press **[OK]**. A question mark (?) appears.

```
>Print RAM Disk  
File List ?
```

- 4 Press **[OK]** again. The message `Processing` appears and the printer prints a list of files stored in a RAM disk.

### Print SSD File List

This allows you to print a list of the files on the SSD.

**IMPORTANT** This is only displayed when the printer has a SSD installed and the disk is correctly formatted.

- 1 Press  $\triangleright$  while `Report Print >` is displayed.
- 2 Press  $\triangle$  or  $\nabla$  repeatedly until `>Print SSD File List` appears.
- 3 Press **[OK]**. A question mark (?) appears.

```
>Print SSD  
File List ?
```

- 4 Press **[OK]** again. The message `Processing` appears and the printer prints a list of files stored in a SSD.



## USB Memory (USB memory selection)

This specifies the settings for removing the USB memory and printing USB memory content. The `USB Memory` menu automatically appears when you install the USB memory.

**IMPORTANT** This message is displayed only when the USB host block is set to `Unblock`. For more information, please refer to *I/F Block (Interface (external device) block setting)* on page 2-80.

The options available in USB Memory are as follows:

- Print File (Printing a file)
  - Copies (Number of copies)
  - Paper Source (Selecting the paper feed source)
- Remove Device (Removing the USB memory)
- Print File List (Printing a list of the files on a USB memory)

**1** Press **[MENU]**.

**2** Press  $\Delta$  or  $\nabla$  repeatedly until `USB Memory >` appears.

Note that menus shown in the list may vary depending on which optional units installed in the printer.

```
USB Memory >
```

### Print File (Printing a file)

You can use this to specify printing for files in the USB memory.

**1** Press  $\triangleright$  while `USB Memory >` is displayed.

**2** `>Print File` appears. In other displays, press  $\Delta$  or  $\nabla$  repeatedly until the map appears.

**3** Press **[OK]**. A question mark (?) appears.

**4** Press **[OK]** again. The folder or file appears.

(For example: `Folder 1`)

Each time you press  $\Delta$  or  $\nabla$ , the next folder or file appears in succession.

```
/
/00:Folder 1
```

```
/00:Folder 1
/01:Folder 2
```

```
/.../01:Folder 2
02:File 3
```

To view lower-level folders or files, press  $\triangleright$ .

(For example: `Folder 2`)

To view folders or files on still lower levels, press  $\triangleright$ .

(For example: `File 3`)

**IMPORTANT** The `Print File` menu option is only displayed when there is a PDF, TIFF, JPEG or XPS file in the USB memory. Note also that up to 3 levels of folders or files are displayed. It might take some time before the folder or file name appears, depending on the size of the USB memory or the number of files.

You can move between the folder levels by pressing  $\Delta$  and  $\nabla$  or  $\triangleleft$  and  $\triangleright$ .

**5** Press **[OK]**. A question mark (?) appears.

(For example: `File 3`)

```
/.../01:Folder 2
? 02:File 3
```

**6** Press **[OK]** again. `Copies` appears.

```
Copies
001
```

---

## Copies (Number of copies)

Sets the number of copies printed of the specified file in USB memory.

**IMPORTANT** To use this feature, an optional SSD must be installed in the printer or the RAM disk must be set to On.

Copies  
010

**1** While `Copies` in step 5 above is displayed, press  $\Delta$  and  $\nabla$  or  $\triangleleft$  and  $\triangleright$  to display the number of copies. (E.g.: 10)

Paper Source  
? Cassette 1

**2** Press **[OK]**. `Paper Source` and a question mark (?) appears.

## Paper Source (Selecting the paper feed source)

Sets the paper used for printing the specified file in USB memory.

Paper Source  
? Cassette 2

**1** While `Paper Source` in step 2 above is displayed, press  $\Delta$  and  $\nabla$  or  $\triangleleft$  and  $\triangleright$  repeatedly until the paper source appears. (For example : `Cassette 2`)

Note that menus shown in the list may vary depending on which optional units installed in the printer.

**2** Press **[OK]**. The message `Processing` appears and the printer prints a file stored in a USB memory.

## Remove Device (Removing the USB memory)

Specifies the setting for USB memory removal.

>Remove Device ?

**1** Press  $\triangleright$  while `USB Memory >` is displayed.

**2** Press  $\Delta$  or  $\nabla$  repeatedly until `>Remove Device` appears.

**3** Press **[OK]**. A question mark (?) appears.

**4** Press **[OK]** again. Menu display ends and the USB memory device can be removed.

## Print File List (Printing a list of the files on a USB memory)

This allows you to print a list of the files on a USB memory device.

>Print File List ?

**1** Press  $\triangleright$  while `USB Memory >` is displayed.

**2** Press  $\Delta$  or  $\nabla$  repeatedly until `>Print File List` appears.

**3** Press **[OK]**. A question mark (?) appears.

**4** Press **[OK]** again. The message `Processing` appears and the printer prints a list of files stored in a USB memory.

---

## Custom Box (Using a Custom Box)

**IMPORTANT** To use a Custom Box, an optional SSD must be installed in the printer. The SSD must be formatted from the printer. For more information, refer to *SSD (Using the optional SSD) on page 2-67*.

A Custom Box is general-purpose box that allows users to store print data on the printer's SSD so that it can be reused as required.

Use the Embedded Web Server RX to create and delete a Custom Box, but use the printer driver to send data stored in the box. For more information, refer to the *Embedded Web Server RX User Guide* and *Printing System Driver User Guide*.

Use the printer's operation panel to print the print data stored in a Custom Box.

The options available in Custom Box are as follows:

- Select Box (Box number : Box name) (Selecting the Custom Box)
- Print Box List (Prints a Custom Box list)

**1** Press **[MENU]**.

**2** Press  $\Delta$  or  $\nabla$  repeatedly until `Custom Box >` appears.



Custom Box >

### Select Box (Box number : Box name) (Selecting the Custom Box)

Use this procedure to select the Custom Box containing your document.

**IMPORTANT** The `Select Box` menu item only appears when there is a Custom Box.

**1** Press  $\triangleright$  while `Custom Box >` is displayed.

**2** Press  $\Delta$  or  $\nabla$  repeatedly until `>Select Box` appears. The box number and box name are displayed. (For example : `0001:Box 1`)

**3** Press **[OK]**. A blinking question mark (?) appears before the box number.

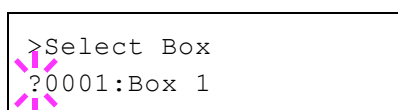

>Select Box  
?0001:Box 1

**4** Press  $\Delta$  or  $\nabla$  repeatedly until the desired box number and box name is displayed. Box numbers from 0001 to 1000 are displayed. Press  $\triangleleft$  or  $\triangleright$  to scroll and view long box names.

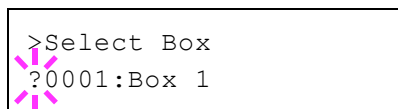

>Select Box  
?0001:Box 1

**5** Press **[OK]** to display the desired Custom Box.

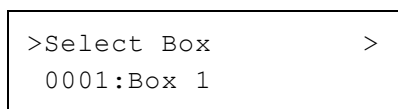

>Select Box >  
0001:Box 1

Next, refer to *Manipulating Data in the Custom Box on page 2-19*.

**IMPORTANT** If you have set a password for the Custom Box, carry out the *Box Password (Box password input)* step next.

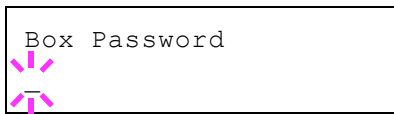

### Box Password (Box password input)

User access to a Custom Box can be restricted by specifying a password for the box. The password is specified from the printer driver.

- 1** If you have set a password for the Custom Box, press  $\triangleright$  while `>Select Box >` is displayed. `Box Password` is displayed and the blinking cursor (`_`) appears.
- 2** Press  $\triangle$  or  $\nabla$  to increase or decrease, respectively, the value at the blinking cursor. Enter the specified password. Press  $\triangleleft$  or  $\triangleright$  to move the cursor left or right.
- 3** Press **[OK]** to set the password and proceed to the next step *Manipulating Data in the Custom Box*.

**IMPORTANT** After you enter your password, the printer checks the password. If you entered the password incorrectly, `Wrong Password` is displayed and the input screen reappears. Re-enter the password correctly.

### Manipulating Data in the Custom Box

The items you can manipulate in the Custom Box are as follows:

- Print All Files (Prints all the data)
- Box number : Box name / Document number : Document name (Selects the data)
- Delete All Files (Deletes all the data)
- Print File List (Prints a document list)

**IMPORTANT** The menus `Box number:Box name/Document number: Document name`, `Print All Files`, and `Delete All Files` are displayed when more than one document.

### Print All Files (Prints all the data)

Use this procedure to print all the documents in the Custom Box.

- 1** Press  $\triangleright$  while `>Select Box >` and the box number and box name are displayed.

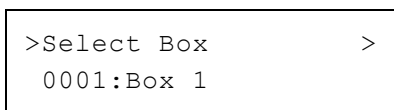

Press  $\triangle$  or  $\nabla$  until `>>Print All Files,` and press **[OK]**. A question mark (?) is displayed.

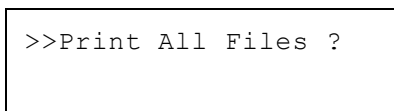

- 2** Press **[OK]** again. The screen for setting the number of copies appears. Press  $\triangle$ ,  $\nabla$ ,  $\triangleleft$  or  $\triangleright$  to enter the number of copies. (E.g. : 10)

You can select a number between 001 and 999 as the number of copies.

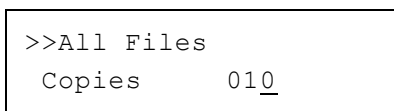

- 3** Press **[OK]**. The screen for selecting the paper source appears. Press  $\triangle$  or  $\nabla$  repeatedly until the desired paper source is displayed. Depending on the installed optional units, one or more of the following are displayed:

MP tray  
Cassette (only the printer's standard cassette used)

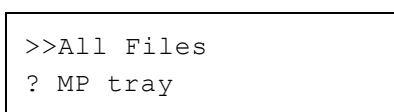

Cassette 1 to 4 (optional paper feeder installed)  
Auto

```
>>Delete after Printed  
? Off
```

- 4 Press **[OK]**. The screen for choosing whether to delete the data after printing appears with a blinking question mark (?).
- 5 Select **Off** or **On** using  $\Delta$  or  $\nabla$ .
- 6 Press **[OK]**. **Processing** is displayed and the specified number of copies of all the documents are printed. If you selected **On** in the **Delete after Printed** screen, all the documents are deleted after printing ends.

### Box number : Box name / Document number : Document name (Selects the data)

Use this procedure to select a document and then print or delete the selected document.

```
>Select Box >  
0001:Box 1
```

```
>>0001:Box 1  
?0001:Data 1
```

```
>>0001:Data 1  
Copies 010
```

```
>>0001:Data 1  
? MP tray
```

```
>>Delete after Printed  
? Off
```

- 1 Press **[OK]** while **>Select Box >** and the box number and box name are displayed.

The document number and document name are displayed beneath the box number and box name with a blinking question mark (?) in front of the document number. Select the document name. (For example: 0001:Data 1)

- 2 Press  $\Delta$  or  $\nabla$  repeatedly until the desired document number and document name is displayed.

- 3 Press **[OK]**. The screen for setting the number of copies appears. Press  $\Delta$ ,  $\nabla$ ,  $\triangleleft$  or  $\triangleright$  to enter the number of copies (e.g.: 10).

You can select a number between 001 and 999 as the number of copies.



**Note** If you select **Delete** in step 3, the selected document can be deleted. Press **[OK]**. **Processing** is displayed, and the selected document in the Custom Box is deleted.

- 4 Press **[OK]**. The screen for selecting the paper source appears. Press  $\Delta$  or  $\nabla$  repeatedly until the desired paper source is displayed. Depending on the installed optional units, one or more of the following are displayed:

MP tray  
Cassette (only the printer's standard cassette used)  
Cassette 1 to 4 (optional paper feeder installed)  
Auto

- 5 Press **[OK]**. The screen for choosing whether to delete the data after printing appears with a blinking question mark (?).

- 6 Select **Off** or **On** using  $\Delta$  or  $\nabla$ .

- 7 Press **[OK]**. **Processing** is displayed and the specified number of copies of the selected document are printed. If you selected **On** in the **Delete after Printed** screen, the selected document is deleted after printing ends.

---

### Delete All Files (Deletes all the data)

Use this procedure to delete all the documents in the Custom Box.

```
>Select Box >
0001:Box 1
```

- 1 Press  $\triangleright$  while `>Select Box >` and the box number and box name are displayed.

```
>>Delete All Files ?
```

Press  $\triangle$  or  $\nabla$  until `>>Delete All Files`, and press **[OK]**. A question mark (?) is displayed.

- 2 Press **[OK]** again. `Processing` is displayed, and all the documents in the Custom Box are deleted.

### Print File List (Prints a document list)

Use this procedure to print a list of the documents in the selected Custom Box.

```
>Select Box >
0001:Box 1
```

- 1 Press  $\triangleright$  while `>Select Box >` and the box number and box name are displayed.

```
>>Print File List ?
```

Press  $\triangle$  or  $\nabla$  until `>>Print File List`, and press **[OK]**. A question mark (?) is displayed, press **[OK]**.

- 2 Press **[OK]** again. `Processing` is displayed and a list of the documents in the selected Custom Box is printed.

### Print Box List (Prints a Custom Box list)

Use this procedure to print a Custom Box list.

```
>Print Box List ?
```

- 1 Press  $\triangleright$  while `Custom Box >` is displayed.
- 2 Press  $\triangle$  or  $\nabla$  repeatedly until `>Print Box List` appears. Press **[OK]**. A question mark (?) appears.

- 3 Press **[OK]** again. `Processing` is displayed and a Custom Box list is printed.

## Job Box

**IMPORTANT** To use the Job Box, an optional SSD must be installed in the printer. The SSD must be formatted from the printer. For more information, refer to *SSD (Using the optional SSD) on page 2-67*. The RAM disk may also be used in the Proof-and-Hold and Private Print modes. For more information, refer to *RAM Disk Mode (Using the RAM disk) on page 2-66*.

Job Box is a print function that makes the Job Retention function possible. The settings are specified from the printer driver. Refer to *Printing System Driver User Guide* for the driver settings.

### Job Retention

Job Retention has four modes as summarized below. These modes are selected from the printer driver through the application software:

	Quick Copy	Proof-and-Hold	Private Print	Stored Job
Primary function	To later print additional copies	To proof the first copy before printing multiple copies	To hold the document in printer to prevent unauthorized access	To electronically store documents such as fax cover pages
Start storing by	Printer driver	Printer driver	Printer driver	Printer driver
On terminating print setting from application software	Prints simultaneously	Prints one copy simultaneously	Does not print	Does not print
Retrieved by	Operation panel	Operation panel	Operation panel	Operation panel
Default number of copies printed at retrieval	Same as storing (can be changed)	One less (can be changed)	Same as storing (can be changed)	One (can be changed)
Maximum number of jobs stored †	32, expandable to 50	32, expandable to 50	Depends on the SSD capacity (the job is automatically deleted after printing)	Depends on the SSD capacity
PIN security	No	No	Yes	Yes (if necessary)
Data after printing	Stored	Stored	Deleted	Stored
Data at power off	Deleted	Deleted	Deleted	Stored
SSD	Necessary	Unnecessary (RAM disk may also be used)	Unnecessary (RAM disk may also be used)	Necessary

†. Jobs in excess will cause the earlier ones to be deleted.



**Note** Refer to the *Printing System Driver User Guide* for the driver settings and print (save) procedures.

The options available in Job Box are as follows:

- Using Quick Copy/Proof-and-Hold  
Quick Copy (User Name) (Selecting the User)  
(User Name) (Data Name) (Selecting the data)  
(Data Name) Copies (number of copies) (Number of copies / deleted)

- Printing a Private Print/Stored Job  
Private/Stored (User Name) (Selecting the User)  
(User Name) (Data Name) (Selecting the data)  
(Data Name) ID (number of copies) (Input passwords)  
(Data Name) Copies (number of copies) (Number of copies / deleted)
- Job Box Configuration (Job Box Configuration)

**1** Press **[MENU]**.

**2** Press  $\Delta$  or  $\nabla$  repeatedly until Job Box > appears.

```
Job Box >
```

Note that menus shown in the list may vary depending on which optional units installed in the printer.

### Quick Copy (Using Quick Copy)

This mode enables you to print the requested number of copies of a job, simultaneously storing the job on the SSD. When additional copies are required, you can reprint the required number of copies from the printer operation panel. To print a job as a quick copy job, refer to *Printing System Driver User Guide*.

The default number of print jobs that can be stored on the SSD is 32. This value can be increased to up to 50 from the Job Box Configuration menu. For details, refer to *Changing the Maximum Number of Quick Copy on page 2-27*. When the number of jobs reaches the limit, the oldest job will be overwritten by the new one.

When the printer is turned off, all stored jobs will be deleted.



**Note** Refer to the *Printing System Driver User Guide* for the driver settings.

### Printing Additional Copies using Quick Copy

**1** Press  $\triangleright$  while Job Box > is displayed.

**2** Press  $\Delta$  or  $\nabla$  repeatedly until >Quick Copy appears. The name entered in the printer driver (Harold, in this example) also appears.

**3** Press **[OK]**. A blinking question mark (?) appears before the user name.

```
>Quick Copy
?Harold
```

**4** Press  $\Delta$  or  $\nabla$  to display the desired user name, Arlen, in this example.

```
>Quick Copy
?Arlen
```

**5** Press **[OK]**. The job name entered in the printer driver (Report, in this example) appear with a blinking question mark (?) before the letters.

```
>Arlen
?Report
```

**6** Press  $\Delta$  or  $\nabla$  to scroll to the desired job title.



**Note** If you selected All Files, this process is applied to all the documents in the Quick Copy/Proof-and-Hold.



```
>Report
Copies      001
```

- 7 Press **[OK]**. The number of copies to be printed can be set. To increase the copy count, press  $\Delta$ ; to decrease the copy count, press  $\nabla$ .



**Note** If you selected *All Files*, press  $\Delta$  after *Copies --* is displayed to set the number of copies. When using the number of copies specified with print job, select *Copies ---*.

- 8 Press **[OK]** to finalize the copy count. The printer prints the specified number of copies for the job.

### Deleting a Quick Copy Job

```
>Report
Copies      001
```

```
>Report
Delete
```

- 1 Follow steps 1 through 6 in the above section to let the title of the job to be deleted displayed.

- 2 When the title of the job to be deleted is displayed, e.g. *Report*, press **[OK]**. The cursor ( $\_$ ) below the copy count starts to blink.

- 3 Press  $\nabla$  repeatedly until *Delete* appears below the title.



**Note** If you selected *All Files*, this process is applied to all the documents in the Quick Copy/Proof-and-Hold.

- 4 Press **[OK]**. The message *Processing* appears and the stored quick copy job is deleted.

### Using Proof-and-Hold

When you print multiple copies, this mode first prints one copy so that you can proof it before continuing to print the remaining copies. Since you can proof the printouts before printing the remaining copies, wastage of paper can be reduced.

The printer prints one copy and, at the same time, saves the print job on the SSD/RAM disk. You can also change the number of copies when resuming printing from the operation panel.

When the printer is turned off, all stored jobs will be deleted.



**Note** Refer to *Printing System Driver User Guide* for the driver settings.

### Printing Remaining Copies of a Proof-and-Hold Job

```
>Quick Copy
?Harold
```

```
>Quick Copy
?Arlen
```

- 1 Press  $\triangleright$  while *Job Box >* is displayed.
- 2 Press  $\Delta$  or  $\nabla$  repeatedly until *>Quick Copy* appears. The name entered in the printer driver (*Harold*, in this example) also appears.
- 3 Press **[OK]**. A blinking question mark (?) appears before the user name.
- 4 Press  $\Delta$  or  $\nabla$  to display the desired user name, *Arlen*, in this example.

```
>Arlen
?Report
```

**5** Press **[OK]**. The job name entered in the printer driver (`Report`, in this example) appear with a blinking question mark (?) before the letters.

**6** Press  $\Delta$  or  $\nabla$  to scroll to the desired job title.



**Note** If you selected `All Files`, this process is applied to all the documents in the `Quick Copy/Proof-and-Hold`.

```
>Report
Copies      001
```

**7** Press **[OK]**. The number of copies to be printed can be set. To increase the copy count, press  $\Delta$  to decrease the copy count, press  $\nabla$ .



**Note** If you selected `All Files`, press  $\Delta$  after `Copies --` is displayed to set the number of copies. When using the number of copies specified with print job, select `Copies ---`.

**8** Press **[OK]** to finalize the copy count. The printer prints the specified number of copies for the job.

### Deleting a Proof-and-Hold Job

**1** Follow steps 1 through 6 in the above section to let the title of the job to be deleted displayed.

**2** When the title of the job to be deleted is displayed, e.g. `Report`, press **[OK]**. The cursor ( `_` ) below the copy count starts to blink.

```
>Report
Copies      001
```

**3** Press  $\nabla$  repeatedly until `Delete` appears below the title.

```
>Report
Delete
```

**4** Press **[OK]**. The message `Processing` appears and the stored job is deleted.

### Private/Stored (Printing a private print/stored job)

In private printing, you can specify that a job is not printed until you release the job from the operation panel. When sending the job from the application software, specify a 4-digit access code in the printer driver. The job is released for printing by entering the access code on the operation panel ensuring confidentiality of the print job.

In the stored job mode, access codes are not mandatory, but can be set on the printer driver if printing with PIN security is required. Then, the access code must be entered on the operation panel to print a stored job. Print data will be stored in the SSD after printing.

Refer to *Printing System Driver User Guide* for the driver settings.

### Releasing a Private/Stored Job

**1** Press  $\triangleright$  while `Job Box >` is displayed.

**2** Press  $\Delta$  or  $\nabla$  repeatedly until `>Private/Stored` appears. The name entered in the printer driver (`Harold`, in this example) also appears.

**3** Press **[OK]**. A blinking question mark (?) appears before the user name.

```
>Private/Stored
?Harold
```

```
>Arlen
?Agenda
```

- Press  $\Delta$  or  $\nabla$  to display the desired user name (Arlen, in this example).
- Press **[OK]**. The user name and the job name (Agenda, in this example) entered in the printer driver appear with a blinking question mark (?).

- Press  $\Delta$  or  $\nabla$  to display the desired job title.



**Note** If you selected `All Files`, this process is applied to all the documents in the Private/Stored Job.

```
>Agenda
ID          0000
```

- Press **[OK]**. The ID input line appears. Enter the four-digit access code entered in the printer driver and press **[OK]**.

To enter the ID, press  $\triangleleft$  or  $\triangleright$  to move the cursor to the number to be changed and then enter the correct number by pressing  $\Delta$  or  $\nabla$ .



**Note** If you selected `All Files` and the stored access code does not match any of the documents, or if no access codes was specified, `ID error` is displayed.

```
>Agenda
Copies      001
```

- You can set the number of copies to be printed. To increase the copy count, press  $\Delta$ ; to decrease the copy count, press  $\nabla$ .



**Note** If you selected `All Files`, press  $\Delta$  after `Copies --` is displayed to set the number of copies.

- Press **[OK]** to finalize the copy count. The printer prints the specified number of copies for the job.

### Deleting a Private/Stored Job

You can individually delete stored jobs by performing the following procedure. Jobs saved using Private Print will be automatically deleted if you turn the power off after printing, but jobs saved using Stored Job will not be deleted automatically.

- Follow steps 1 through 6 in the above section.
- When the title of the job to be printed is displayed (Agenda, in this example), press **[OK]**. Enter the four-digit access code entered in the printer driver and press **[OK]**.

```
>Agenda
Copies      001
```

- Press  $\nabla$  repeatedly until `Delete` appears for the number of copies.

```
>Agenda
Delete
```

- Press **[OK]**. The private job is deleted.

### Job Box Configuration

Change Job Box settings, such as the maximum number of storable documents in the SSD, and automatic delete settings.

The following items are available in the Job Box detail settings.

- Changing the Maximum Number of Quick Copy
- Set Automatic Delete times for Temporary Jobs

---

## Changing the Maximum Number of Quick Copy

This changes maximum number of Quick Copy from 0 to 50. The default is 32.

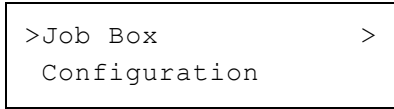

>Job Box Configuration >

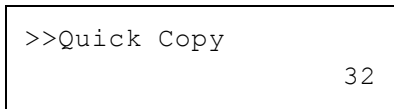

>>Quick Copy 32

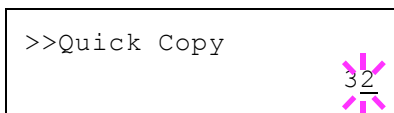

>>Quick Copy 32

- 1 Press  $\triangleright$  while Job Box > is displayed.
- 2 Press  $\triangle$  or  $\nabla$  repeatedly until >Job Box Configuration > appears.

- 3 Press  $\triangleright$ .

- 4 Press  $\triangle$  or  $\nabla$  repeatedly until >>Quick Copy appears.

- 5 Press [OK]. A blinking cursor (   ) appears.

- 6 Press  $\triangle$  or  $\nabla$  to increase or decrease the value at the blinking cursor. The value can be set between 0 and 50. Use  $\triangleleft$  and  $\triangleright$  to move the cursor right and left.

- 7 When the desired maximum number of jobs is set, press [OK].

- 8 Press [MENU]. The display returns to Ready.

## Set Automatic Delete times for Temporary Jobs

- 1 Press  $\triangleright$  while Job Box > is displayed.

- 2 Press  $\triangle$  or  $\nabla$  repeatedly until >Job Box Configuration > appears.

- 3 Press  $\triangleright$ .

- 4 Press  $\triangle$  or  $\nabla$  repeatedly until >>Delete appears.

- 5 Press [OK]. A blinking question mark (?) appears.

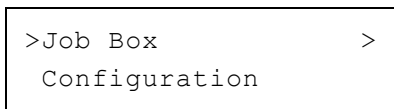

>Job Box Configuration >



>>Delete  
? Off

- 6 Press  $\triangle$  or  $\nabla$  repeatedly until the desired Automatic Delete time is displayed. The list shows the following times:

Off (automatic delete is not performed)

1 hour (deleted in 1 hour)

4 hours (deleted in 4 hours)

1 day (deleted on the next day)

1 week (deleted after one week)

- 7 Press [OK].

- 8 Press [MENU]. The display returns to Ready.

---

## Counter (Viewing the counter value)

Displays the number of pages printed.

The options available in Counter are as follows:

- Printed Pages (Displaying the total printed pages)
- Color (Displaying the color printed pages)
- Black & White (Displaying the Black & White printed pages)

**1** Press **[MENU]**.

**2** Press  $\Delta$  or  $\nabla$  repeatedly until `Counter >` appears.

```
Counter >
```

## Printed Pages (Displaying the total printed pages)

This only displays the total number of pages printed. You cannot change the displayed number.

**1** Press  $\triangleright$  while `Counter >` is displayed.

**2** Press  $\Delta$  or  $\nabla$  repeatedly until `>Printed Pages` appears. The total number of pages printed is displayed. (E.g.: 2000)

```
>Printed Pages  
2000
```

**3** Press **[MENU]**. The display returns to `Ready`.

## Color (Displaying the color printed pages)

This only displays the number of color pages printed. You cannot change the displayed number.

**1** Press  $\triangleright$  while `Counter >` is displayed.

**2** Press  $\Delta$  or  $\nabla$  repeatedly until `>Color` appears. The total number of pages printed is displayed. (E.g.: 1000)

```
>Color  
1000
```

**3** Press **[MENU]**. The display returns to `Ready`.

## Black & White (Displaying the Black & White printed pages)

This only displays the number of Black & White pages printed. You cannot change the displayed number.

**1** Press  $\triangleright$  while `Counter >` is displayed.

**2** Press  $\Delta$  or  $\nabla$  repeatedly until `>Black & White` appears. The total number of pages printed is displayed. (E.g.: 1000)

```
>Black & White  
1000
```

**3** Press **[MENU]**. The display returns to `Ready`.

---

## Paper Settings

This sets the paper size and type for the MP tray and cassettes from which paper is supplied.

The options available in Paper Settings are as follows:

- MP Tray Size (Setting MP tray paper size)
- MP Tray Type (Setting the MP tray paper type)
- Cassette (1 to 4) Size (Setting the cassette paper size)
- Cassette (1 to 4) Type (Setting the cassette paper type)
- Type Adjust (Creating custom paper type)
- Reset Type Adjust (Resetting the custom paper type)

**1** Press **[MENU]**.

**2** Press  $\Delta$  or  $\nabla$  repeatedly until `Paper Settings >` appears.

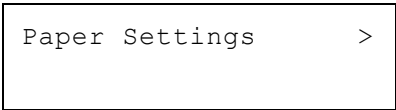

Paper Settings >

### MP Tray Size (Setting MP tray paper size)

When you use the MP tray, you should set the MP tray size to the paper size that is used to format the job to print. If the sizes do not match, printing will not be performed on the correct size paper.

The default setting is `Letter` size for the U.S. and Canada and `A4` for other countries. For more information about the paper sizes that you can feed from the MP tray, refer to *Paper Specifications on page 1-2*.



**Note** Feeding the paper having a paper size which does not match the current paper size from the MP tray can cause paper jam.

**1** Press  $\triangleright$  while `Paper Settings >` is displayed.

**2** Press  $\Delta$  or  $\nabla$  repeatedly until `>MP Tray Size` appears.

**3** Press **[OK]**. A blinking question mark (?) appears.

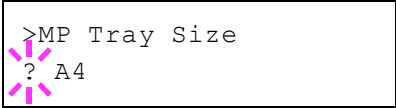

>MP Tray Size  
? A4

**4** Press  $\Delta$  or  $\nabla$  to display the desired paper size. The message display toggles through the following paper sizes:

Envelope Monarch  
Envelope #10  
Envelope DL  
Envelope C5  
Executive  
Letter  
Legal  
A4  
B5  
A5  
A6  
B6  
Envelope #9  
Envelope #6  
ISO B5  
Custom  
Hagaki  
Oufuku Hagaki

Oficio II  
216x340mm  
16K  
Statement  
Folio  
Youkei 2  
Youkei 4

- 5 Press **[OK]**.
- 6 Press **[MENU]**. The display returns to *Ready*.

### MP Tray Type (Setting the MP tray paper type)

You can use this to set the paper type that can be supplied from the MP tray. The default setting is *PLAIN*.

For more information about paper types that you can feed from the MP tray, refer to *Paper Specifications on page 1-2*.

- 1 Press  $\triangleright$  while *Paper Settings >* is displayed.
- 2 Press  $\triangle$  or  $\nabla$  repeatedly until *>MP Tray Type* appears.
- 3 Press **[OK]**. A blinking question mark (?) appears.

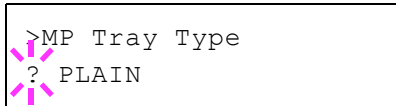

>MP Tray Type  
? PLAIN

- 4 Press  $\triangle$  or  $\nabla$  to display the desired paper type. The message display toggles through the following paper types:

PLAIN  
TRANSPARENCY  
PREPRINTED  
LABELS  
BOND  
RECYCLED  
VELLUM  
ROUGH  
LETTERHEAD  
COLOR  
PREPUNCHED  
ENVELOPE  
CARDSTOCK  
COATED  
THICK  
HIGH QUALITY  
CUSTOM 1 (to 8)



**Note** You can define any paper type and store that definition in the printer. For more information, refer to *Type Adjust (Creating custom paper type)* on page 2-34.

- 5 Press **[OK]**.
- 6 Press **[MENU]**. The display returns to *Ready*.

## Cassette (1 to 4) Size (Setting the cassette paper size)

To set the standard sizes A5, A4, B5, Letter, and Legal size for the paper cassette, load the paper and turn the paper size dial so that the size of the paper you are going to use appears in the paper size window. To load a non-standard paper size (sizes other than A5, A4, B5 and Letter) into a paper cassette, refer to the custom paper sizes listed on *page 2-31*.

If the PF-500 or PF-510 optional paper feeder is installed, use the same procedure to load paper into the paper feeder cassettes.

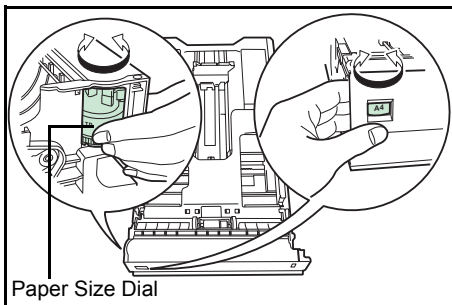

- 1 Pull the cassette out of the printer and set the paper size using the paper size dial.

- 2 Adjust the paper guides in the cassette to the size of the paper to be used for printing and load the paper into the cassette.

## Custom Paper Size

If you use a non-standard size paper, load the paper and turn the paper size dial to **Other** (refer to *Loading Paper on page 1-14*).

## Selecting the Size Dial Setting

- 1 Pull the cassette out of the printer and set the paper size dial to **Other**. For details, refer to step 1 in *Cassette (1 to 4) Size (Setting the cassette paper size) on page 2-31*.
- 2 Adjust the paper guides in the cassette to the size of the paper to be used for printing and load the paper into the cassette.

## Setting the Paper Size from the Operation Panel

Use the operation panel to set the size of paper loaded in the cassette on the printer. This menu appears if the size dial for the cassette is set to **Other**.

- 1 Press  $\triangleright$  while `Paper Settings >` is displayed.
- 2 Press  $\triangle$  or  $\nabla$  repeatedly until `>Cassette Size >` appears. If optional paper feeders are added, `Cassette 1 Size` will appear for the standard paper cassette and `Cassette 2 Size`, `Cassette 3 Size`, and `Cassette 4 Size` will appear for the optional paper feeders.
- 3 Press **[OK]**. A blinking question mark (?) appears.
- 4 Press  $\triangle$  or  $\nabla$  to display the desired paper size. The message display toggles through the following paper sizes:

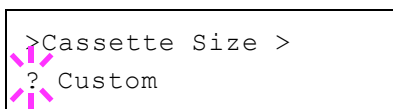

Envelope Monarch  
Envelope #10  
Envelope DL  
Envelope C5  
Executive



Letter  
Legal  
A4  
B5  
A5  
A6  
Envelope #9  
Envelope #6  
ISO B5  
Custom  
Oufuku Hagaki  
Oficio II  
216x340mm  
16K  
Statement  
Folio  
Youkei 2  
Youkei 4



**Note** A6 is displayed for Cassette Size or Cassette 1 Size.

Envelope Monarch, Envelope #10, Envelope #9, Envelope #6, Envelope DL, OufukuHagaki, Youkei 2 and Youkei 4 are displayed when one of cassettes 2 to 4 in the optional paper feeder PF-500/PF-510 is installed.

- 5 When the desired paper size is displayed, press **[OK]**. The paper size is set for the paper cassette.

If you selected `Custom` in step 4, be sure to set the unit of measurement and the dimensions of the paper as described in the following sections.

Select the units of measurement as described in the next section.

### Unit (Selecting the unit of measurement)

- 1 Press **[>]**.
- 2 Press **[△]** or **[▽]** repeatedly until `>>Unit` appears. The unit of measurement can be selected between millimeters and inches. The current unit of measurement is displayed (the default setting is `mm`).
- 3 Press **[OK]**. A blinking question mark (?) appears.



- 4 Select `mm` or `inch` using **[△]** or **[▽]**.
- 5 Press **[OK]**.

Set the dimensions of the paper as described in the next section.

## Entering the Width and Length

Enter the paper size for X Dimension and Y Dimension as shown in the figure.

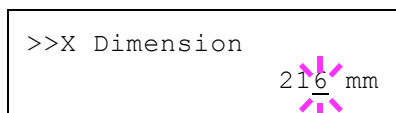
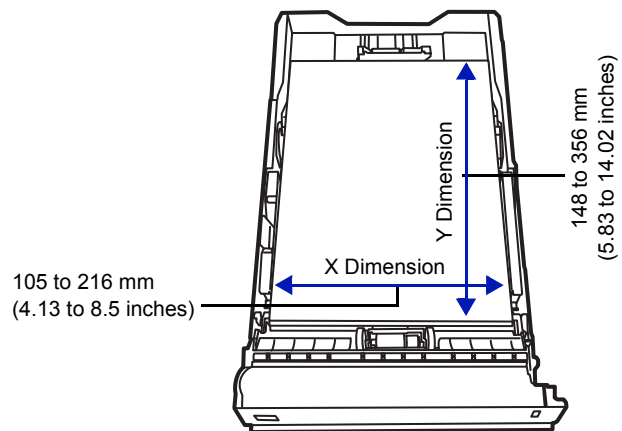

- 1 When the unit of measurement is set, press  $\nabla$ .  
>>X Dimension appears (the paper width setting).
- 2 Press [OK]. A blinking cursor (  $\text{⏏}$  ) appears.
- 3 Press  $\triangle$  or  $\nabla$  to increase or decrease the value of the figure where the cursor is blinking and display the desired width.  
Acceptable paper widths are as follows:
  - Cassette : 105 to 216 mm (4.13 to 8.5 inches)
  - Paper Feeder PF-500/PF-510 (optional) : 92 to 216 mm (3.62 to 8.5 inches)
- 4 Display the paper width and press [OK].
- 5 When the width is set, press  $\nabla$ . >>Y Dimension appears (the paper length setting). Set the desired length in the same way as the width.  
Acceptable paper lengths are as follows:
  - Cassette : 148 to 356 mm (5.83 to 14.02 inches)
  - Paper Feeder PF-500/PF-510 (optional) : 162 to 356 mm (6.38 to 14.02 inches)
- 6 Display the paper length, press [OK].
- 7 Press [MENU]. The display returns to Ready.

## Cassette (1 to 4) Type (Setting the cassette paper type)

By setting a paper type (plain, recycled, etc.) for the paper cassette, you can automatically select the paper in the paper cassette according to the paper type you command on the printer driver. The default setting is plain paper for all paper cassettes.

If the PF-500 or PF-510 optional paper feeder is installed, use the same procedure to setting the cassette paper type.

For more information about paper types that you can feed from the paper cassette, refer to *Paper Specifications* on page 1-2.

- 1 Press  $\triangleright$  while Paper Settings > is displayed.
- 2 Press  $\triangle$  or  $\nabla$  repeatedly until >Cassette Type appears.

```
>Cassette Type
? PLAIN
```

If optional paper feeders are added, *Cassette 1 Type* will appear for the standard paper cassette and *Cassette 2 Type*, *Cassette 3 Type*, and *Cassette 4 Type* will appear for the optional paper feeders.

- 3 To change paper type, press **[OK]**. A blinking question mark (?) appears.

- 4 Press  $\Delta$  or  $\nabla$  to display the desired paper type. The message display toggles through the following paper types:

```
PLAIN
PREPRINTED
LABELS
BOND
RECYCLED
ROUGH
LETTERHEAD
COLOR
PREPUNCHED
ENVELOPE
CARDSTOCK
COATED
THICK
HIGH QUALITY
CUSTOM 1 (to 8)
```

**IMPORTANT** LABELS, ENVELOPE, CARDSTOCK and COATED will only appear when the optional paper feeder PF-510 is installed.



**Note** You can define any paper type and store that definition in the printer. For more information, refer to *Type Adjust (Creating custom paper type)* on page 2-34.

- 5 Press **[OK]**.
- 6 Press **[MENU]**. The display returns to *Ready*.

### Type Adjust (Creating custom paper type)

The following describes the procedure used to set a user-defined paper type for the printer. Eight custom user settings may be registered. After having been set, any of these may be called up when setting the paper type for a paper source.

The paper weight and duplex path can be set (refer to *Paper Weight (Setting the paper weight)* on page 2-35, and *Duplex Path (Setting the duplex path)* on page 2-35) after selecting the paper type to be customized as follows. For how to reset the customized settings, refer to *Reset Type Adjust (Resetting the custom paper type)* on page 2-36.

- 1 Press  $\triangleright$  while *Paper Settings >* is displayed.
- 2 Press  $\Delta$  or  $\nabla$  repeatedly until *>Type Adjust >* appears.
- 3 Press **[OK]**. A blinking question mark (?) appears.

```
>Type Adjust >
? PLAIN
```

- 
- 4 Press  $\Delta$  or  $\nabla$  to display the desired paper type. The display changes as shown below.

PLAIN  
TRANSPARENCY  
PREPRINTED  
LABELS  
BOND  
RECYCLED  
VELLUM  
ROUGH  
LETTERHEAD  
COLOR  
PREPUNCHED  
ENVELOPE  
CARDSTOCK  
COATED  
THICK  
HIGH QUALITY  
CUSTOM 1 (to 8)

- 5 Press [OK].
- 6 Press  $\triangleright$  and proceed to the next step *Paper Weight (Setting the paper weight)*.

#### Paper Weight (Setting the paper weight)

You can set the paper thickness for your custom paper type to be customized. The default setting is Normal 2.

- 1 Display the custom paper type (refer to *Type Adjust (Creating custom paper type)* on page 2-34) and press  $\triangleright$ .
- 2 Press  $\Delta$  or  $\nabla$  repeatedly until `>>Paper Weight` appears.
- 3 Press [OK]. A blinking question mark (?) appears.

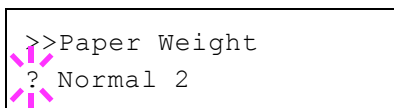

```
>>Paper Weight  
? Normal 2
```

- 4 Press  $\Delta$  or  $\nabla$  to display the desired paper thickness. The display changes as shown below. For details of the default setting for each paper type, refer to *Paper Specifications* on page 1-2.

Light  
Normal 1  
Normal 2  
Normal 3  
Heavy 1  
Heavy 2  
Heavy 3  
Extra Heavy

- 5 Press [OK].
- 6 Press [MENU]. The display returns to Ready.

#### Duplex Path (Setting the duplex path)

- 1 Display the custom paper type (refer to *Type Adjust (Creating custom paper type)* on page 2-34) and press  $\triangleright$ .
- 2 Press  $\Delta$  or  $\nabla$  repeatedly until `>>Duplex Path` appears.

---

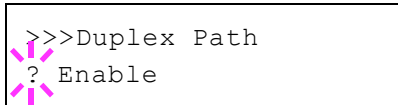

```
>>>Duplex Path
? Enable
```

**3** Press **[OK]**. A blinking question mark (?) appears.

**4** Select `Enable` or `Disable` using  $\Delta$  or  $\nabla$ . For details of the default setting for each paper type, refer to *Paper Specifications on page 1-2*.

**5** Press **[OK]**.

**6** Press **[MENU]**. The display returns to `Ready`.

The custom paper type setting is completed.

### Reset Type Adjust (Resetting the custom paper type)

Reset all the custom paper type that was set in *Type Adjust (Creating custom paper type) on page 2-34*.

**1** Press  $\triangleright$  while `Paper Settings >` is displayed.

**2** Press  $\Delta$  or  $\nabla$  repeatedly until `>Reset Type Adjust` appears.

**3** Press **[OK]**. A question mark (?) appears.

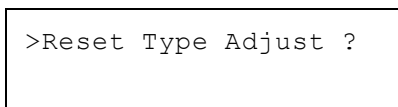

```
>Reset Type Adjust ?
```

**4** Press **[OK]** again. All customized paper types will be reset to the default. The display returns to `Ready`.

---

## Print Settings

These settings specify printing parameters such as the print quality used for printing (Normal or Fine), the gloss mode (Low or High), the number of copies, reduced printing and the page orientation.

The options available in Print Settings are as follows:

- Paper Source (Selecting the paper feed source)
- Auto Cass. Change (Auto Cassette Change setting)
- Paper Feed Mode (Setting the paper feed source)
- Duplex (Duplex printing)
- Override A4/LT (Overriding difference between A4 and Letter)
- Emulation (Setting the emulation)
- Color Mode (Selecting color or Black & White printing)
- Print Quality (Setting print quality)
- Page Set (Setting pagination)
- Job Name (The Job Name display settings)

**1** Press **[MENU]**.

**2** Press  $\Delta$  or  $\nabla$  repeatedly until `Print Settings >` appears.

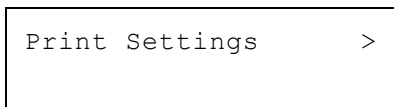

```
Print Settings >
```

### Paper Source (Selecting the paper feed source)

You can select the paper source, from which the printer feeds paper as the default. If an optional paper feeder(s) is installed, it is also available for the default paper source.

**1** Press  $\triangleright$  while `Print Settings >` is displayed.

**2** Press  $\Delta$  or  $\nabla$  repeatedly until `>Paper Source` appears.

**3** To change the current paper feed source, press **[OK]**. A blinking question mark (?) appears.

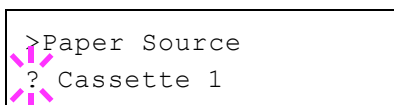

```
>Paper Source  
? Cassette 1
```

**4** Press  $\Delta$  or  $\nabla$  to display the desired paper feed source. The message display toggles through the following paper feed sources, depending on the installed optional paper feeders (from the top most paper cassette to the bottom paper cassette):

```
MP tray  
Cassette 1  
Cassette 2  
Cassette 3  
Cassette 4
```

Cassettes 2, 3 and 4 are available for selection when the optional paper feeders are installed.

**5** Press **[OK]**.

**6** Press **[MENU]**. The display returns to `Ready`.

## Auto Cass. Change (Auto Cassette Change setting)

You can select the following actions when the paper runs out in the paper source while printing. By default, this feature is On.

<b>Off</b>	The printer displays <code>Load Cassette #</code> (# is a cassette number) or <code>Load MP Tray</code> , and stops printing. Load the paper according to the paper source displayed to resume printing. To print from the other paper cassette, press $\Delta$ or $\nabla$ to display <code>Use alternative?</code> , press $\Delta$ or $\nabla$ to select the desired paper source, and then press <b>[GO]</b> .
<b>On</b>	The printer continues printing automatically when the other paper cassette contains the same paper as the currently-used paper cassette.

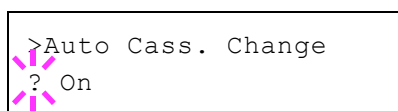

```
>Auto Cass. Change
? On
```

- 1 Press  $\triangleright$  while `Print Settings >` is displayed.
- 2 Press  $\Delta$  or  $\nabla$  repeatedly until `>Auto Cass. Change` appears.
- 3 To change the current paper feed source, press **[OK]**. A blinking question mark (?) appears.
- 4 Select `On` or `Off` using  $\Delta$  or  $\nabla$ .
- 5 Press **[OK]**.
- 6 Press **[MENU]**. The display returns to `Ready`.



**Note** You can also configure the Auto Cassette Change in the Embedded Web Server RX. Access to the Embedded Web Server RX, and then go to **Basic > Defaults > Device Defaults** page. For more information on access to the Embedded Web Server RX, refer to the *Embedded Web Server RX User Guide*.

## Paper Feed Mode (Setting the paper feed source)

This mode specifies how the paper should be fed once the paper feed source and paper type have been chosen. If `Auto` is selected, the printer searches for a paper feed source that matches the paper size and type, and paper is then delivered from that source. If `Fixed` is selected and there is no matching paper feed source, handling proceeds as specified by `Paper Mismatch for Error Handling`. For details on paper feeding when `Fixed` is selected, refer to *Paper Mismatch (Detection settings for paper size/type errors when the paper source is fixed)* on page 2-68. The default setting is `Auto`. To change the settings, follow the steps described below.



```
>Paper Feed Mode
? Auto
```

- 1 Press  $\triangleright$  while `Print Settings >` is displayed.
- 2 Press  $\Delta$  or  $\nabla$  repeatedly until `>Paper Feed Mode` appears.
- 3 Press **[OK]**. A blinking question mark (?) appears.
- 4 Press  $\Delta$  or  $\nabla$  until `Auto` or `Fixed` appears.
- 5 Press **[OK]**.
- 6 Press **[MENU]**. The display returns to `Ready`.

---

## When the Paper Runs Out During Printing

When Paper Feed Mode is set to Fixed, if the paper in the cassette runs out during printing, Load Cassette 1 is displayed and the printer stands by. In this event, either replenish the paper in the empty cassette or use the procedure below to print from another paper source.

- 1 While Load Cassette 1 is displayed, press  $\Delta$  or  $\nabla$  repeatedly until Use alternative? appears.
- 2 Press  $\Delta$  or  $\nabla$  repeatedly until the desired paper source and size appears.  
Each time you press  $\Delta$  or  $\nabla$ , another paper cassette or the paper size that can currently be fed from the MP tray appears.
- 3 Press [OK]. Printing continues.

## Duplex (Duplex printing)

Using the duplexer, you can automatically print on both sides of the paper. The duplexer is mounted underneath the printer.

Duplex printing is available for the following paper types:

PLAIN  
PREPRINTED  
BOND  
RECYCLED  
ROUGH  
LETTERHEAD  
COLOR  
PREPUNCHED  
THICK  
HIGH QUALITY

Activating the duplexer is done by selecting either short edge or long edge binding mode.



**Note** Duplex printing can be also performed from the MP tray. If the paper to be fed from the MP tray does not match the paper size and paper type of the current paper feed source cassette, a paper jam may occur.

**IMPORTANT** Duplex printing for coated paper (COATED) is possible if the optional paper feeder PF-510 is installed.



## Binding Modes

Binding refers to the manner in which printed pages of paper are joined together (by gluing, stitching, etc.) in book form. The two possible types of binding are: long-edge binding, in which pages are joined together along their long edge; and short-edge binding, in which they are joined together along their short edge. In selecting a binding type, you must also consider the orientation of the printed page. You can use long-edge or short-edge binding with either landscape or portrait printing.

Depending on the binding type and print orientation, the duplexer provides four types of binding. These are: (1) portrait, long-edge, (2) portrait, short edge, (3) landscape, long-edge, and (4) landscape, short-edge. The figure below shows these binding methods.

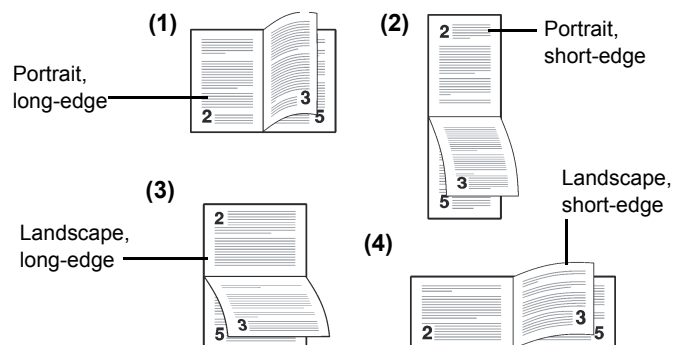

- 1 Press  $\triangleright$  while `Print Settings >` is displayed.
- 2 Press  $\triangle$  or  $\nabla$  repeatedly until `>Duplex` appears.
- 3 Press **[OK]**. A blinking question mark (?) appears.
- 4 Press  $\triangle$  or  $\nabla$  to display the desired binding mode. The message display toggles through the following:
  - Off (default)
  - Short edge bind
  - Long edge bind
- 5 Press **[OK]**.
- 6 Press **[MENU]**. The display returns to `Ready`.

---

## Override A4/LT (Overriding difference between A4 and Letter)

When the `Override A4/LT` is turned `On` using the operation panel, the printer ignores the difference between A4 and Letter paper sizes. Printing is performed without an error message even if the actual paper size in the current cassette differs from the paper size formatting the job.

By default, this feature is `On`.

- 1 Press `▷` while `Print Settings >` is displayed.
- 2 Press `△` or `▽` repeatedly until `>Override A4/LT` appears.
- 3 Press **[OK]**. A blinking question mark (?) appears.

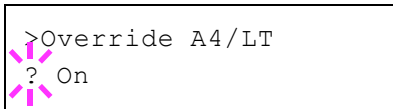

```
>Override A4/LT
? On
```

- 4 Select `On` or `Off` using `△` or `▽`.
- 5 Press **[OK]**.
- 6 Press **[MENU]**. The display returns to `Ready`.

## Emulation (Setting the emulation)

You can change the emulation mode for the current interface. Use the procedure below to select the mode.

- 1 Press `▷` while `Print Settings >` is displayed.
- 2 Press `△` or `▽` repeatedly until `>Emulation >` appears on the message display. One of the emulation modes appears, indicating the emulation currently in use.
- 3 Press **[OK]**. A blinking question mark (?) appears.

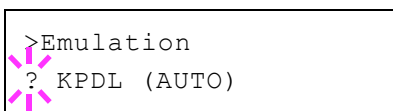

```
>Emulation
? KPDL (AUTO)
```

- 4 Press `△` or `▽` repeatedly until the desired emulation mode is displayed.

```
PCL 6
KPDL
KPDL (AUTO) (default)
```

- 5 Press **[OK]**.
- 6 Press **[MENU]**. The display returns to `Ready`.

## Error Report (Printing KPDL errors)

The printer can print error descriptions when printing error occurs during KPDL emulation. The default is `On` — the printer does not print KPDL errors.

- 1 Press `▷` while `Print Settings >` is displayed.
- 2 Press `△` or `▽` repeatedly until `>Emulation >` appears.
- 3 Press **[OK]**. A blinking question mark (?) appears.



```
>Emulation
? PCL 6
```

```
>Emulation >
? KPDL (AUTO)
```

**4** Select **KPDL** or **KPDL (AUTO)** using  $\Delta$  or  $\nabla$ . Press **[OK]**.

```
>>Error Report
? On
```

**5** Press  $\triangleright$ . **>>Error Report** appears.

**6** Press **[OK]**. A blinking question mark (?) appears.

**7** Select **On** or **Off** using  $\Delta$  or  $\nabla$ . Press **[OK]**.

**8** Press **[MENU]**. The display returns to **Ready**.

### Color Mode (Selecting color or Black & White printing)

You can use the Color Mode menu on the operation panel to select the Black & White or Color printing mode. By default, the printer is set to print in color mode.

```
>Color Mode
? Color
```

**1** Press  $\triangleright$  while **Print Settings >** is displayed.

**2** Press  $\Delta$  or  $\nabla$  repeatedly until **>Color Mode** appears.

**3** Press **[OK]**. A blinking question mark (?) appears.

**4** Press  $\Delta$  or  $\nabla$  to change color mode — **Color** or **Black & White**.

**5** When the desired color mode is displayed, press **[OK]**. Color mode is changed.

**6** Press **[MENU]**. The display returns to **Ready**.

### Print Quality (Setting print quality)

This selects the gloss mode (**Low** or **High**) and whether **EcoPrint** (low-toner printing) is used for printing.

The options available in **Print Quality** are as follows:

- **Gloss Mode** (Selecting the gloss mode)
- **EcoPrint Mode** (Selecting the **EcoPrint** mode)

**1** Press  $\triangleright$  while **Print Settings >** is displayed.

**2** Press  $\Delta$  or  $\nabla$  repeatedly until **>Print Quality >** appears.

```
>Print Quality >
```

### Gloss Mode (Selecting the gloss mode)

Gloss mode, when set to **High**, increases the effect of glossiness in printing by reducing the printing speed by half. Gloss mode is not available when **LABELS** and **TRANSPARENCY** is selected as the paper type setting.

**IMPORTANT** Depending on the paper used, printing in gloss mode may cause wrinkle in paper. To reduce wrinkle, try using thicker paper.

Use the procedure below to select Gloss mode. The default setting is **Low**.

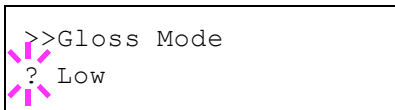

- 1 Press  $\triangleright$  while `>Print Quality >` is displayed.
- 2 Press  $\triangle$  or  $\nabla$  repeatedly until `>>Gloss Mode` appears.
- 3 Press **[OK]**. A blinking question mark (?) appears.
- 4 Select `Low` or `High` using  $\triangle$  or  $\nabla$ .
- 5 Press **[OK]**.
- 6 Press **[MENU]**. The display returns to `Ready`.

### EcoPrint Mode (Selecting the EcoPrint mode)

By enabling EcoPrint mode, you can minimize the amount of toner used during printing. Because images printed in this mode may be slightly coarser than those printed in standard resolution, you should use EcoPrint for test prints or other situations where high-quality prints are not required.

Use the procedure below to select EcoPrint mode. The default setting is `Off`.

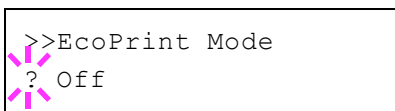

- 1 Press  $\triangleright$  while `>Print Quality >` is displayed.
- 2 Press  $\triangle$  or  $\nabla$  repeatedly until `>>EcoPrint Mode` appears.
- 3 Press **[OK]**. A blinking question mark (?) appears.
- 4 Select `On` or `Off` using  $\triangle$  or  $\nabla$ .
- 5 Press **[OK]**.
- 6 Press **[MENU]**. The display returns to `Ready`.

### Page Set (Setting pagination)

In Page Set menus, you can set the number of copies, page orientation, and other settings regarding pagination.

The options available in Page Set are as follows:

- Copies (Number of copies)
- Orientation (Print orientation)
- Wide A4 (Wide A4 pitch)
- XPS FitTo Page (Print area setting for XPS data)
- TIFF/JPEG Size (Print mode setting for TIFF/JPEG files)

- 1 Press  $\triangleright$  while `Print Settings >` is displayed.
- 2 Press  $\triangle$  or  $\nabla$  repeatedly until `>Page Set >` appears.



### Copies (Number of copies)

You can set the number of copies of each page to be printed for the current interface.

Press  $\triangleright$  while `>Page Set >` is displayed.



- 1** Press  $\Delta$  or  $\nabla$  repeatedly until >>Copies appears.
- 2** Press **[OK]**. A blinking cursor (    ) appears.
- 3** Press  $\Delta$  or  $\nabla$  to increase or decrease, respectively, the value at the blinking cursor. The number of copies can be set between 1 and 999. Use  $\triangleleft$  and  $\triangleright$  to move the cursor right and left.
- 4** When the desired size is displayed, press **[OK]**.
- 5** Press **[MENU]**. The display returns to Ready.

### Orientation (Print orientation)

You can select portrait (upright) or landscape (sideways) page orientation.

Portrait Orientation



Landscape Orientation

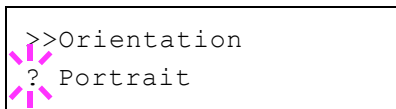
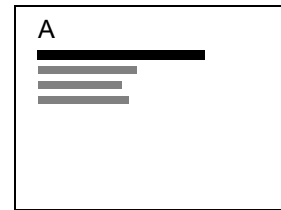

- 1** Press  $\triangleright$  while >Page Set > is displayed.
- 2** Press  $\Delta$  or  $\nabla$  repeatedly until >>Orientation appears.
- 3** Press **[OK]**. A blinking question mark (?) appears.
- 4** Select Portrait or Landscape using  $\Delta$  or  $\nabla$ .
- 5** Press **[OK]**.
- 6** Press **[MENU]**. The display returns to Ready.

### Wide A4 (Wide A4 pitch)

Turn this to On to increase the maximum number of characters that can be printed in a line for an A4 page (78 characters at 10 pitch) and Letter size page (80 characters at 10 pitch). This setting is only effective in PCL 6 emulation.

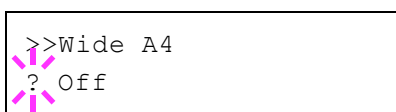

- 1** Press  $\triangleright$  while >Page Set > is displayed.
- 2** Press  $\Delta$  or  $\nabla$  repeatedly until >>Wide A4 appears.
- 3** Press **[OK]**. A blinking question mark (?) appears.
- 4** Select On or Off using  $\Delta$  or  $\nabla$ .
- 5** Press **[OK]**.

- 6 Press **[MENU]**. The display returns to *Ready*.

#### **XPS FitTo Page (Print area setting for XPS data)**

Select *On* in this setting to enlarge or reduce XPS files to fit the printable area during printing.

- 1 Press  $\triangleright$  while *>Page Set >* is displayed.
- 2 Press  $\triangle$  or  $\nabla$  repeatedly until *>>XPS FitTo Page* appears.
- 3 Press **[OK]**. A blinking question mark (?) appears.

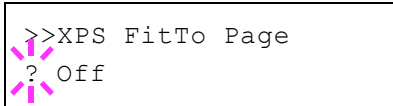

```
>>XPS FitTo Page
? Off
```

- 4 Select *On* or *Off* using  $\triangle$  or  $\nabla$ .
- 5 Press **[OK]**.
- 6 Press **[MENU]**. The display returns to *Ready*.

#### **TIFF/JPEG Size (Print mode setting for TIFF/JPEG files)**

Use this setting to select the printing method used when TIFF or JPEG files are printed directly. The default setting is *Paper Size*.

- 1 Press  $\triangleright$  while *>Page Set >* is displayed.
- 2 Press  $\triangle$  or  $\nabla$  repeatedly until *>>TIFF/JPEG Size* appears.
- 3 Press **[OK]**. A blinking question mark (?) appears.

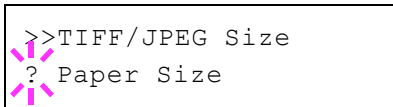

```
>>TIFF/JPEG Size
? Paper Size
```

- 4 Press  $\triangle$  or  $\nabla$  repeatedly until the desired print mode is displayed. The list shows the following print modes:
  - Paper Size* (scaled to fit the paper size)  
Images are resized so that they fill the paper size when printed.
  - Image Resolution* (matched to the image resolution)  
Image files are printed at the resolution specified in the resolution information. Images with no resolution information are printed using the *Paper Size* setting.
  - Print Resolution* (matched to the print resolution)  
Images are printed using a 1-to-1 correspondence between the image file pixels and printed dots. For example, the printed size of a 600 × 300-pixel image file is 1 inch × 1/2 inch.
- 5 Press **[OK]**.
- 6 Press **[MENU]**. The display returns to *Ready*.



**Note** Images are automatically rotated during printing to provide a closer match between the aspect ratios of the image file and the paper used for printing.

---

### Job Name (The Job Name display settings)

Set whether the job name set in the printer driver is displayed.

- 1 Press  $\triangleright$  while `Print Settings >` is displayed.
- 2 Press  $\triangle$  or  $\nabla$  repeatedly until `>Job Name` appears.
- 3 Press **[OK]**. A blinking question mark (?) appears.



- 4 Press  $\triangle$  or  $\nabla$  to display the job name to be used.
  - Off (Use the job name set in the printer driver.)
  - Job Name
  - Job No.+Job Name
  - Job Name+Job No.
- 5 When the desired color mode is displayed, press **[OK]**. Color mode is changed.
- 6 Press **[MENU]**. The display returns to `Ready`.

---

## Network (Network settings)

This printer supports TCP/IP and TCP/IP (IPv6) protocols.

IP is an abbreviation for Internet Protocol. This printer routinely uses the TCP/IP (IPv4) protocol, but provides a separate setting for the next-generation IP, IPv6.

TCP/IP (IPv4) uses 32-bit IP addresses, but the rapid growth in the number of Internet users has resulted in a shortage of IP addresses. IPv6 was developed to expand the range of available IP addresses by using 128-bit IP addresses.

The options available in the Network settings are as follows:

- TCP/IP (IPv4 settings)
- TCP/IP (IPv6) (IPv6 settings)
- Protocol Detail (Detailed settings for the network protocol)
- Restart Network (Restarting the network card)



**Note** Check with your network administrator when selecting the network setting. After all network related settings have been done, restart the network. Refer to *Restart Network (Restarting the network card)* on page 2-55. This is mandatory to make the settings effective!

When Embedded Web Server RX is used, network parameters and security settings can be conveniently changed and checked from your PC. For more information, refer to the *Embedded Web Server RX User Guide*.

- 1** Press **[MENU]**.
- 2** Press  $\Delta$  or  $\nabla$  repeatedly until `Network >` appears.



### TCP/IP (IPv4 settings)

This selects the settings for TCP/IP (IPv4).

The TCP/IP system refers to the Internet system, which has a 5-layer structure consisting of the interface layer, link layer, network (IP) layer, transport (TCP/UDP) layer and application layer.

The interface layer is a key layer in the TCP/IP system that provides an abstracted interface that is not dependent on the link (communication line: frame relay or Ethernet, etc.) to the IP module (IP layer). This means that the IP module can use this abstracted interface (which is not dependent on the link type) to exchange IP packets back and forth with the link layer.

The options available in the TCP/IP (IPv4) settings are as follows:

- DHCP (DHCP setting)
- Auto-IP (Auto-IP setting)
- IP Address (IP address setting)
- Subnet Mask (Subnet mask setting)
- Gateway (Gateway setting)
- Bonjour (Bonjour setting)

**IMPORTANT** The DHCP, IP address, subnet mask, gateway and Bonjour menu options for TCP/IP are displayed when TCP/IP is enabled.





```
>TCP/IP >
? Off
```

- 1 Press  $\triangleright$  while `Network >` is displayed.
- 2 Press  $\triangle$  or  $\nabla$  repeatedly until `>TCP/IP >` appears.
- 3 Press **[OK]**. A blinking question mark (?) appears.

- 4 Select `On` or `Off` using  $\triangle$  or  $\nabla$ .
- 5 Select `On` and press **[OK]**. Configure the settings shown below.

#### DHCP (DHCP setting)

DHCP (Dynamic Host Configuration Protocol) is the protocol that assigns the information required to establish a network connection when a host attempts to connect to the network (Internet). This information includes the IP address of the local node and the default router (the router in the host's own network system) and the DNS (Domain Name System) server. DHCP is an extension of the BOOTP (Bootstrap) startup protocol.



```
>>DHCP
? Off
```

- 1 Press  $\triangleright$  while `>TCP/IP On >` is displayed.
- 2 Press  $\triangle$  or  $\nabla$  repeatedly until `>>DHCP` appears.
- 3 Press **[OK]**. A blinking question mark (?) appears.

- 4 Select `On` or `Off` using  $\triangle$  or  $\nabla$ .
- 5 Press **[OK]**.
- 6 Press **[MENU]**. The display returns to `Ready`.

#### Auto-IP (Auto-IP setting)

This protocol is used for automatic assignment of an IP address when you connect to a small network that does not have a DHCP server. Select an address from the range 169.254.0.1 to 169.254.255.254, and if no other device on the network is using that address, it is used as your address.



```
>>Auto-IP
? Off
```

- 1 Press  $\triangleright$  while `>TCP/IP On >` or `>TCP/IP Off >` is displayed.
- 2 Press  $\triangle$  or  $\nabla$  repeatedly until `>>Auto-IP` appears.
- 3 Press **[OK]**. A blinking question mark (?) appears.

- 4 Select `On` or `Off` using  $\triangle$  or  $\nabla$ .
- 5 Press **[OK]**.
- 6 Press **[MENU]**. The display returns to `Ready`.

---

## IP Address (IP address setting)

An IP address is the address of a network device such as a computer and is included in IP packets as needed for the sending and receiving of Internet data (IP packets). (IP addresses can be either destination addresses or source addresses.)

Specifically, an IP address is a bit string consisting of a host address (or host section) that identifies a computer connected to the Internet and a network address (or network section) that identifies the network to which that computer belongs (or more specifically, the computer's network interface). Bit strings (IP addresses) that are unique throughout the entire Internet system are allocated to each computer or interface.

The IP addresses currently used on the Internet (IPv4) have a fixed length of 32 bits.

 **Note** When you enter the IP address, be sure to set the DHCP setting to Off.

- 1 Press  $\triangleright$  while `>TCP/IP On >` is displayed.
- 2 Press  $\triangle$  or  $\nabla$  repeatedly until `>>IP Address` appears.
- 3 Press **[OK]**. A blinking cursor (`_`) appears.

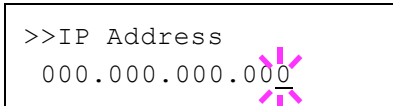

```
>>IP Address
000.000.000.000
```

- 4 Press  $\triangle$  or  $\nabla$  to increase or decrease, respectively, the value at the blinking cursor. You can set any value between 000 and 255. Use  $\triangleleft$  and  $\triangleright$  to move the cursor right and left.
- 5 Display the desired IP address and press **[OK]**.
- 6 Press **[MENU]**. The display returns to Ready.

## Subnet Mask (Subnet mask setting)

The subnet mask is a way of augmenting the network address section of an IP address.

A subnet mask represents all network address sections as 1 and all host address sections as 0. The number of bits in the prefix indicates the length of the network address. The term "prefix" refers to something added to the beginning and, in this context, indicates the first section of the IP address.

When an IP address is written, the length of the network address can be indicated by the prefix length after a forward slash (/). For example, "24" in the address "133.210.2.0/24". In this way, "133.210.2.0/24" denotes the IP address "133.210.2.0" with a 24-bit prefix (network section).

This new network address section (originally part of the host address) made possible by the subnet mask is referred to as the subnet address.

 **Note** When you enter the subnet mask, be sure to set the DHCP setting to Off.

- 1 Press  $\triangleright$  while `>TCP/IP On >` is displayed.
- 2 Press  $\triangle$  or  $\nabla$  repeatedly until `>>Subnet Mask` appears.

```
>>Subnet Mask
000.000.000.000
```

- 3 Press **[OK]**. A blinking cursor (    ) appears.
- 4 Press  $\Delta$  or  $\nabla$  to increase or decrease, respectively, the value at the blinking cursor. You can set any value between 000 and 255. Use  $\triangleleft$  and  $\triangleright$  to move the cursor right and left.
- 5 Display the desired subnet mask and press **[OK]**.
- 6 Press **[MENU]**. The display returns to *Ready*.

### Gateway (Gateway setting)

Gateway generally refers to a protocol conversion device used to allow networks with differing protocol systems to interconnect.

For example, a "Gateway" device is required to connect a different closed network (using its own protocols) to the open Internet (using TCP/IP).

By installing a gateway, the communications protocols and data display modes on different networks can be made compatible.

On TCP/IP networks, the term gateway is used to refer to routers.



**Note** Before you input the gateway, be sure to set the DHCP setting to *Off*.

- 1 Press  $\triangleright$  while *>TCP/IP On >* is displayed.
- 2 Press  $\Delta$  or  $\nabla$  repeatedly until *>>Gateway* appears.
- 3 Press **[OK]**. A blinking cursor (    ) appears.

```
>>Gateway
000.000.000.000
```

- 4 Press  $\Delta$  or  $\nabla$  to increase or decrease, respectively, the value at the blinking cursor. You can set any value between 000 and 255. Use  $\triangleleft$  and  $\triangleright$  to move the cursor right and left.
- 5 Display the desired gateway and press **[OK]**.
- 6 Press **[MENU]**. The display returns to *Ready*.

### Bonjour (Bonjour setting)

Bonjour, also known as zero-configuration networking, is a service that automatically detects computers, devices and services on an IP network.

Bonjour, because an industry-standard IP protocol is used, allows devices to automatically recognize each other without an IP address being specified or DNS server being set.

Bonjour also sends and receives network packets by UDP port 5353. If a firewall is enabled, the user must check that UDP port 5353 is left open so that Bonjour will run correctly. Some firewalls are set up so as to reject only certain Bonjour packets. If Bonjour does not run stably, check the firewall settings and ensure that Bonjour is registered on the exceptions list and that Bonjour packets are accepted. If you install Bonjour on Windows XP Service Pack 2 or later, the Windows firewall will be set up correctly for Bonjour.

- 1 Press  $\triangleright$  while *>TCP/IP On >* is displayed.
- 2 Press  $\Delta$  or  $\nabla$  repeatedly until *>>Bonjour* appears.

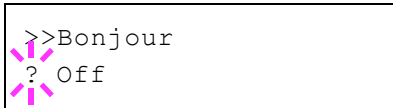

**3** Press **[OK]**. A blinking cursor ( `_` ) appears.

**4** Select `On` or `Off` using `△` or `▽`.

**5** Press **[OK]**.

**6** Press **[MENU]**. The display returns to `Ready`.

### TCP/IP (IPv6) (IPv6 settings)

This selects the settings for TCP/IP (IPv6).

TCP/IP (IPv6) is based on the current Internet protocol, TCP/IP (IPv4). IPv6 is the next-generation Internet protocol and expands the available address space, which resolves the problem of the lack of addresses under IPv4, while also introducing other improvements such as additional security functionality and the capacity to prioritize data transmission.

The options available in the TCP/IP (IPv6) settings are as follows:

- RA (Stateless) (RA (Stateless) setting)
- DHCPv6 (DHCPv6 setting)

**IMPORTANT** The RA (Stateless) and DHCPv6 menu options for TCP/IP (IPv6) are displayed when TCP/IP (IPv6) is enabled.

**1** Press `▷` while `Network >` is displayed.

**2** Press `△` or `▽` repeatedly until `>TCP/IP (IPv6) >` appears.

**3** Press **[OK]**. A blinking question mark (?) appears.

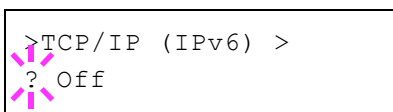

**4** Select `On` or `Off` using `△` or `▽`.

**5** Select `On` and press **[OK]**. Configure the settings shown below.

### RA (Stateless) (RA (Stateless) setting)

The IPv6 router communicates (transmits) information such as the global address prefix using ICMPv6. This information is the Router Advertisement (RA).

ICMPv6 stands for Internet Control Message Protocol, and is a IPv6 standard defined in the RFC 2463 "Internet Control Message Protocol (ICMPv6) for the Internet Protocol Version 6 (IPv6) Specification".

**1** Press `▷` while `>TCP/IP (IPv6) On >` is displayed.

**2** Press `△` or `▽` repeatedly until `>>RA (Stateless)` appears.

**3** Press **[OK]**. A blinking question mark (?) appears.

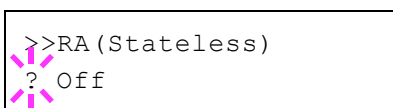

**4** Select `On` or `Off` using `△` or `▽`.

**5** Press **[OK]**.

**6** Press **[MENU]**. The display returns to `Ready`.

### DHCPv6 (DHCPv6 setting)

DHCPv6 is the next-generation of the Internet's Dynamic Host Configuration Protocol and supports IPv6. It extends the BOOTP startup protocol that defines the protocols used for transferring configuration information to hosts on the network.

DHCPv6 permits the DHCP server to use its expanded functionality to send configuration parameters to an IPv6 node. Because the network addresses that can be used are allocated automatically, the IPv6 node management workload is reduced in systems where the administrator has to exercise close control over IP address allocation.

- 1 Press  $\triangleright$  while `>TCP/IP (IPv6) On >` is displayed.
- 2 Press  $\triangle$  or  $\nabla$  repeatedly until `>>DHCPv6` appears.
- 3 Press **[OK]**. A blinking question mark (?) appears.



- 4 Select `On` or `Off` using  $\triangle$  or  $\nabla$ .
- 5 Press **[OK]**.
- 6 Press **[MENU]**. The display returns to `Ready`.

### Protocol Detail (Detailed settings for the network protocol)

This selects the settings for Protocol Detail.

The options available in the Protocol Detail settings are as follows:

- NetBEUI (NetBEUI setting)
- SNMPv3 (SNMPv3 setting)
- FTP (Server) (FTP (Server) setting)
- SNMP (SNMP setting)
- SMTP (SMTP setting)
- POP3 (POP3 setting)
- RAW Port (RAW Port setting)
- LPD (LPD setting)
- HTTP (HTTP setting)

- 1 Press  $\triangleright$  while `Network >` is displayed.
- 2 Press  $\triangle$  or  $\nabla$  repeatedly until `>Protocol Detail >` appears.

### NetBEUI (NetBEUI setting)

Selects whether or not to receive documents using NetBEUI.

- 1 Press  $\triangleright$  while `>Protocol Detail >` is displayed.
- 2 Press  $\triangle$  or  $\nabla$  repeatedly until `>>NetBEUI` appears.
- 3 Press **[OK]**. A blinking question mark (?) appears.



- 4 Select `On` or `Off` using  $\triangle$  or  $\nabla$ .
- 5 Press **[OK]**.
- 6 Press **[MENU]**. The display returns to `Ready`.

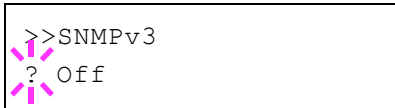

### SNMPv3 (SNMPv3 setting)

Set SNMPv3.

- 1 Press  $\triangleright$  while `>Protocol Detail >` is displayed.
- 2 Press  $\triangle$  or  $\nabla$  repeatedly until `>>SNMPv3` appears.
- 3 Press **[OK]**. A blinking question mark (?) appears.
- 4 Select `On` or `Off` using  $\triangle$  or  $\nabla$ .
- 5 Press **[OK]**.
- 6 Press **[MENU]**. The display returns to `Ready`.

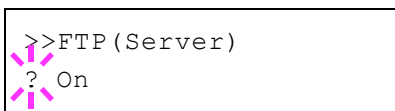

### FTP (Server) (FTP (Server) setting)

Select whether or not to receive documents using FTP.

- 1 Press  $\triangleright$  while `>Protocol Detail >` is displayed.
- 2 Press  $\triangle$  or  $\nabla$  repeatedly until `>>FTP (Server)` appears.
- 3 Press **[OK]**. A blinking question mark (?) appears.
- 4 Select `On` or `Off` using  $\triangle$  or  $\nabla$ .
- 5 Press **[OK]**.
- 6 Press **[MENU]**. The display returns to `Ready`.



### SNMP (SNMP setting)

Select whether or not to communicate using SNMP.

- 1 Press  $\triangleright$  while `>Protocol Detail >` is displayed.
- 2 Press  $\triangle$  or  $\nabla$  repeatedly until `>>SNMP` appears.
- 3 Press **[OK]**. A blinking question mark (?) appears.
- 4 Select `On` or `Off` using  $\triangle$  or  $\nabla$ .
- 5 Press **[OK]**.
- 6 Press **[MENU]**. The display returns to `Ready`.



### SMTP (SMTP setting)

Select whether or not to send email using SMTP.

- 1 Press  $\triangleright$  while `>Protocol Detail >` is displayed.
- 2 Press  $\triangle$  or  $\nabla$  repeatedly until `>>SMTP` appears.
- 3 Press **[OK]**. A blinking question mark (?) appears.
- 4 Select `On` or `Off` using  $\triangle$  or  $\nabla$ .

- 5 Press **[OK]**.
- 6 Press **[MENU]**. The display returns to *Ready*.

### POP3 (POP3 setting)

Select whether or not to receive email using POP3.

- 1 Press  $\triangleright$  while *>Protocol Detail >* is displayed.
- 2 Press  $\triangle$  or  $\nabla$  repeatedly until *>>POP3* appears.
- 3 Press **[OK]**. A blinking question mark (?) appears.



- 4 Select *On* or *Off* using  $\triangle$  or  $\nabla$ .
- 5 Press **[OK]**.
- 6 Press **[MENU]**. The display returns to *Ready*.

### RAW Port (RAW Port setting)

Select whether or not to communicate using RAW Port.

- 1 Press  $\triangleright$  while *>Protocol Detail >* is displayed.
- 2 Press  $\triangle$  or  $\nabla$  repeatedly until *>>RAW Port* appears.
- 3 Press **[OK]**. A blinking question mark (?) appears.

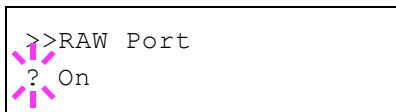

- 4 Select *On* or *Off* using  $\triangle$  or  $\nabla$ .
- 5 Press **[OK]**.
- 6 Press **[MENU]**. The display returns to *Ready*.

### LPD (LPD setting)

Select whether or not to receive documents using LPD as the network protocol.

- 1 Press  $\triangleright$  while *>Protocol Detail >* is displayed.
- 2 Press  $\triangle$  or  $\nabla$  repeatedly until *>>LPD* appears.
- 3 Press **[OK]**. A blinking question mark (?) appears.

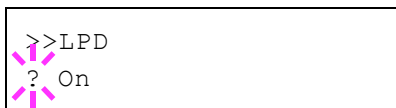

- 4 Select *On* or *Off* using  $\triangle$  or  $\nabla$ .
- 5 Press **[OK]**.
- 6 Press **[MENU]**. The display returns to *Ready*.

### HTTP (HTTP setting)

Select whether or not to communicate using HTTP.

- 1 Press  $\triangleright$  while *>Protocol Detail >* is displayed.
- 2 Press  $\triangle$  or  $\nabla$  repeatedly until *>>HTTP* appears.



**3** Press **[OK]**. A blinking question mark (?) appears.

**4** Select **On** or **Off** using  $\Delta$  or  $\nabla$ .

**5** Press **[OK]**.

**6** Press **[MENU]**. The display returns to **Ready**.

### Restart Network (Restarting the network card)

After all network related settings have been done, restart the network card of the device. This is mandatory to make the settings effective.

**1** Press  $\triangleright$  while **Network >** is displayed.

**2** Press  $\Delta$  or  $\nabla$  repeatedly until **>Restart Network** appears.

**3** Press **[OK]**. A question mark (?) appears.

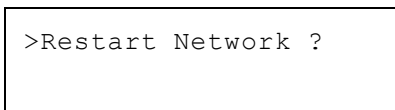

**4** Press **[OK]** again. The message **Restarting... Please wait.** appears and the network is restarted.



---

## Optional Network (Optional Network settings)

This selects the settings for the optional network interface kit (IB-50) or wireless network interface kit (IB-51).



**Note** This is only displayed when a network interface kit (IB-50) or wireless network interface kit (IB-51) is installed as an option.

Refer to the *IB-51 User's Manual* for information on the wireless network settings. Manual setting from the printer is not supported on this device.

The options available in the Optional Network settings are as follows:

- ID (Administrator ID input)
- Password (Administrator Password input)
- TCP/IP (IPv4 settings)
- TCP/IP (IPv6) (IPv6 settings)
- Netware (NetWare setting)
- AppleTalk (AppleTalk setting)
- IPSec (IPSec setting)
- LAN Interface (LAN Interface setting)
- MACAddressFilter (MAC address filtering setting)
- Communication (Select the network interface to use)
- Restart Network (Restarting the optional network interface kit)

**1** Press **[MENU]**.

**2** Press  $\Delta$  or  $\nabla$  repeatedly until `Optional Network >` appears.

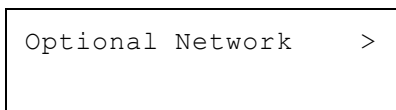

### ID (Administrator ID input)

To use the Optional Network function, you must enter an administrator ID. For information on how to set the administrator ID, refer to *Administrator (Administrator settings) on page 2-94*.

**1** Press  $\triangleright$  while `Optional Network >` is displayed.

**2** The message display shows `ID` and a blinking cursor (`_`).



**3** Press  $\Delta$  or  $\nabla$  to increase or decrease, respectively, the value at the blinking cursor. Enter the specified ID. Use  $\triangleleft$  and  $\triangleright$  to move the cursor right and left. Enter an ID consisting of between 1 and 16 numbers.

**4** Press **[OK]**. Proceed to the next step *Password (Administrator Password input)*.

### Password (Administrator Password input)

To set up the Optional Network functions, you must enter an administrator ID and administrator password. For information on how to set the administrator password, refer to *Administrator (Administrator settings) on page 2-94*.



- 1 Once you have entered the correct ID in the previous step (ID (Administrator ID input)), the message display shows `Password` (Administrator password input) and a blinking cursor (`_`).
- 2 Press  $\Delta$  or  $\nabla$  to increase or decrease, respectively, the value at the blinking cursor. Enter the specified password. Use  $\triangleleft$  and  $\triangleright$  to move the cursor right and left. Enter a password consisting of between 0 (no settings) and 16 numbers.



**Note** If you enter the incorrect administrator ID or password, the message `Wrong ID` or `Wrong Password` appears and the input screen then reappears. Re-enter the ID or password correctly.

- 3 Press **[OK]**. The Optional Network screen appears.

### TCP/IP (IPv4 settings)

This selects the settings for TCP/IP (IPv4). The method for setting is the same as for the standard Network settings. For details, refer to *TCP/IP (IPv4 settings)* on page 2-47.

### TCP/IP (IPv6) (IPv6 settings)

This selects the settings for TCP/IP (IPv6). The method for setting is the same as for the standard Network settings. For details, refer to *TCP/IP (IPv6) (IPv6 settings)* on page 2-51.

### Netware (NetWare setting)

NetWare is a PC-based network operating system specifically for servers. NetWare is a client-server system that operates by installing the NetWare OS on the server and dedicated client modules (NetWare clients) on the client machines (running MS-DOS, OS/2, Windows, etc.). The basic network layer protocol used is NetWare's own IPX (Internetwork Packet eXchange)/SPX (Sequenced Packet eXchange), but the system also supports TCP/IP.

The feature of the NetWare OS is that it is specifically for servers, unlike general-purpose operating systems such as Windows NT and UNIX. Only the minimum required for server operation can be performed from the NetWare OS console on the server. Server and file management is basically carried out using management tools from the clients. Also, all drivers and protocol stacks are in the form of modules called NetWare Loadable Modules (NLMs), and the ability of NLMs to load and unload flexibly and dynamically is a major advantage of this system.

- 1 After entering the administrator ID and password, press  $\Delta$  or  $\nabla$  repeatedly until `>Netware` appears.
- 2 Press **[OK]**. A blinking question mark (?) appears.



- 3 Press  $\Delta$  or  $\nabla$  to select whether NetWare is enabled.
- 4 Press **[OK]**.
- 5 Press **[MENU]**. The display returns to `Ready`.

---

## AppleTalk (AppleTalk setting)

AppleTalk is a communications protocol used primarily on Macintosh computers and also refers to the Mac OS network functions.

AppleTalk assigns 24-bit network addresses (a 16-bit network section and an 8-bit node address) that are used to identify devices (computers, printers, etc.) on the network.

When the power is turned on, a broadcast signal is sent out onto the network and the addresses and machine names are automatically assigned. The default setting is *On*.

**1** After entering the administrator ID and password, press  $\Delta$  or  $\nabla$  repeatedly until *>AppleTalk* appears.

**2** Press **[OK]**. A blinking question mark (?) appears.

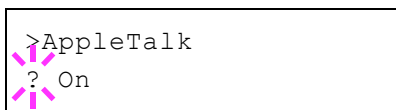

**3** Press  $\Delta$  or  $\nabla$  to select whether AppleTalk is enabled.

**4** Press **[OK]**.

**5** Press **[MENU]**. The display returns to *Ready*.

## IPSec (IPSec setting)

IPSec (IP Security Protocol) is a security protocol adopted as the standard by the IETF for authentication and encryption in the third network layer (IP layer).

It can be used with both IPv4 and IPv6.

 **Note** IPv4 uses 32-bit IP addresses and IPv6 uses 128-bit IP addresses.

**1** After entering the administrator ID and password, press  $\Delta$  or  $\nabla$  repeatedly until *>IPSec* appears.

**2** Press **[OK]**. A blinking question mark (?) appears.



**3** Press  $\Delta$  or  $\nabla$  to select whether IPSec is enabled.

**4** Press **[OK]**.

**5** Press **[MENU]**. The display returns to *Ready*.

## LAN Interface (LAN Interface setting)

Specify the settings for the LAN interface to be used. The default setting is *Auto*.

**1** After entering the administrator ID and password, press  $\Delta$  or  $\nabla$  repeatedly until *>LAN Interface* appears.

**2** Press **[OK]**. A blinking question mark (?) appears.

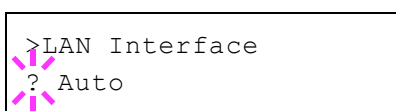

- 
- 3 Press  $\Delta$  or  $\nabla$  to select the desired LAN Interface. The available LAN Interface are as follows:

```
Auto
10BASE-Half
10BASE-Full
100BASE-Half
100BASE-Full
1000BASE-T
```

- 4 Press **[OK]**.
- 5 Press **[MENU]**. The display returns to *Ready*.

### MACAddressFilter (MAC address filtering setting)

This sets whether or not to enable MAC address filtering.

 **Note** The detailed settings for MAC address filtering are selected using the optional network interface kit utility software.

- 1 After entering the administrator ID and password, press  $\Delta$  or  $\nabla$  repeatedly until `>MACAddressFilter` appears.
- 2 Press **[OK]**. A blinking question mark (?) appears.

```
>MACAddressFilter
? Off
```

- 3 Press  $\Delta$  or  $\nabla$  to select whether MAC address filtering is enabled.
- 4 Press **[OK]**.
- 5 Press **[MENU]**. The display returns to *Ready*.

### Communication (Select the network interface to use)

Select the interface to be used for network connection.

- 1 After entering the administrator ID and password, press  $\Delta$  or  $\nabla$  repeatedly until `>Communication` appears.
- 2 Press **[OK]**. A blinking question mark (?) appears.

```
>Communication
? Standard NIC
```

- 3 Press  $\Delta$  or  $\nabla$  to select the desired NIC.  
Standard NIC (standard network interface of the printer)  
Option NIC (optional network interface kit)
- 4 Press **[OK]**.
- 5 Press **[MENU]**. The display returns to *Ready*.

---

## Restart Network (Restarting the optional network interface kit)

After all network related settings have been done, restart the network card of the device. This is mandatory to make the settings effective.

>Restart Network ?

- 1** After entering the administrator ID and password, press  $\Delta$  or  $\nabla$  repeatedly until >Restart Network appears.
- 2** Press **[OK]**. A question mark (?) appears.
- 3** Press **[OK]** again. The message Restating.. Please wait. appears and the network is restarted.

---

## Device Common (Selecting/Setting the common device)

Selects/sets all the functions in this printer.

The options available in Device Common are as follows:

- Message Language (Selecting the message language)
- Date Setting (Date and time settings)
- Buzzer (Alarm (Buzzer) setting)
- RAM Disk Mode (Using the RAM disk)
- SSD (Using the optional SSD)
- Error Handling (Error detection setting)
- Timer (Timer setting)
- Sleep Level Set. (Sleep level setting)
- TonerAlert Level (Setting for the alert level for toner addition)

**IMPORTANT** SSD appears if an optional SSD is inserted and not formatted in the machine.

- 1** Press **[MENU]**.
- 2** Press  $\Delta$  or  $\nabla$  repeatedly until `Device Common >` appears.



Device Common >

### Message Language (Selecting the message language)

You can select the language of the message display by following the procedure given below. You can optionally download messages in other languages. Contact your service technician for information.

- 1** Press  $\triangleright$  while `Device Common >` is displayed.
- 2** Press  $\Delta$  or  $\nabla$  repeatedly until `>Message Language` appears. The default message language is `English`.
- 3** To change the language, press **[OK]**. A blinking question mark (?) appears.
- 4** Press  $\Delta$  or  $\nabla$ . The display cycles through the available selection in the following order:
  - English
  - Français
  - Deutsch
  - Italiano
  - Nederlands
  - Español
  - Русский
  - Português
- 5** Press **[OK]**.
- 6** Press **[MENU]**. The display returns to `Ready`.

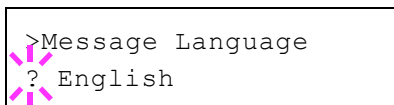

>Message Language  
? English

---

## Date Setting (Date and time settings)

Set the date and time.

The date and time settings consist of the following items:

- ID (Administrator ID input)
- Password (Administrator Password input)
- Date (date setting)
- Time (time setting)
- Date Format (date format selection)
- Time Zone (time difference setting)
- Summer Time (summer time setting)

- 1 Press  $\triangleright$  while `Device Common >` is displayed.
- 2 Press  $\triangle$  or  $\nabla$  repeatedly until `>Date Setting >` appears.

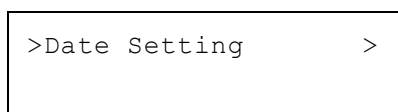

### ID (Administrator ID input)

To use the Date settings, you must enter an administrator ID. For information on how to set the administrator ID, refer to *Administrator (Administrator settings) on page 2-94*.

- 1 Press  $\triangleright$  while `>Date Setting >` is displayed.
- 2 The message display shows `ID` and a blinking cursor (`_`).



- 3 Press  $\triangle$  or  $\nabla$  to increase or decrease, respectively, the value at the blinking cursor. Enter the specified ID. Use  $\triangleleft$  and  $\triangleright$  to move the cursor right and left. Enter an ID consisting of between 1 and 16 numbers.
- 4 Press **[OK]**. Proceed to the next step *Password (Administrator Password input)*.

### Password (Administrator Password input)

To set up the Date settings, you must enter an administrator ID and administrator password. For information on how to set the administrator password, refer to *Administrator (Administrator settings) on page 2-94*.

- 1 Once you have entered the correct ID in the previous step (ID (Administrator ID input)), the message display shows `Password` (Administrator password input) and a blinking cursor (`_`).
- 2 Press  $\triangle$  or  $\nabla$  to increase or decrease, respectively, the value at the blinking cursor. Enter the specified password. Use  $\triangleleft$  and  $\triangleright$  to move the cursor right and left. Enter a password consisting of between 0 (no settings) and 16 numbers.



**Note** If you enter the incorrect administrator ID or password, the message `Wrong ID` or `Wrong Password` appears and the input screen then reappears. Re-enter the ID or password correctly.

- 3 Press **[OK]**. The Date settings screen appears.

```
>>Date (Year/Mon/Day)
 2013 / 01 / 01
```

### Date (date setting)

- 1 After entering the administrator ID and password, press  $\Delta$  or  $\nabla$  repeatedly until `>>Date (Year/Mon/Day)` appears.
- 2 Press **[OK]**. A blinking cursor ( `_` ) appears.
- 3 Use the arrow keys to set the year, month, and day. Press  $\Delta$  or  $\nabla$  to increase or decrease, respectively, the value at the blinking cursor. Use  $\triangleleft$  and  $\triangleright$  to move the cursor right and left.



**Note** The order in which the year, month, and day appear varies depending on the *Date Format (date format selection)* on page 2-63.

- 4 Press **[OK]**.
- 5 Press **[MENU]**. The display returns to `Ready`.

### Time (time setting)

- 1 After entering the administrator ID and password, press  $\Delta$  or  $\nabla$  repeatedly until `>>Time (Hour:Min:Sec)` appears.
- 2 Press **[OK]**. A blinking cursor ( `_` ) appears.

```
>>Time (Hour:Min:Sec)
 11 : 19 : 21
```

- 3 Use the arrow keys to set the hour, minute, and second. Press  $\Delta$  or  $\nabla$  to increase or decrease, respectively, the value at the blinking cursor. Use  $\triangleleft$  and  $\triangleright$  to move the cursor right and left.
- 4 Press **[OK]**.
- 5 Press **[MENU]**. The display returns to `Ready`.

### Date Format (date format selection)

One of three formats can be selected for the date format.

- 1 After entering the administrator ID and password, press  $\Delta$  or  $\nabla$  repeatedly until `>>Date Format` appears.
- 2 Press **[OK]**. A blinking question mark ( `?` ) appears.

```
>>Date Format
 ? Month/Day/Year
```

- 3 Press  $\Delta$  or  $\nabla$  to select `Date Format`. The following date formats can be selected:

Month/Day/Year

Day/Month/Year

Year/Month/Day

- 4 Press **[OK]**.
- 5 Press **[MENU]**. The display returns to `Ready`.



### Time Zone (time difference setting)

Set the time difference from GMT.

```
>>Time zone
? -05:00 Estn Time
```

- 1 After entering the administrator ID and password, press  $\Delta$  or  $\nabla$  repeatedly until `>>Time zone` appears.
- 2 Press **[OK]**. A blinking question mark (?) appears.
- 3 Press  $\Delta$  or  $\nabla$  to select the location.
- 4 Press **[OK]**.
- 5 Press **[MENU]**. The display returns to `Ready`.

### Summer Time (summer time setting)

Set summer time.

```
>>Summer Time
? Off
```

- 1 After entering the administrator ID and password, press  $\Delta$  or  $\nabla$  repeatedly until `>>Summer Time` appears.
- 2 Press **[OK]**. A blinking question mark (?) appears.
- 3 Press  $\Delta$  or  $\nabla$  to select whether the summer time is enabled.
- 4 Press **[OK]**.
- 5 Press **[MENU]**. The display returns to `Ready`.

### Buzzer (Alarm (Buzzer) setting)

This function uses tones to notify the user of printer operations and the printer status. This setting is useful, for example, when the printer is located some distance from the user.

The options available in Buzzer are as follows:

- Key Confirm. (Key confirmation tone setting)
- Job End (Job completed tone setting)
- Ready (Preparation completed tone setting)
- Error (Error tone setting)

```
>Buzzer >
```

- 1 Press  $\triangleright$  while `Device Common >` is displayed.
- 2 Press  $\Delta$  or  $\nabla$  repeatedly until `>Buzzer >` appears.

### Key Confirm. (Key confirmation tone setting)

When `On` is selected in this setting, a tone sounds each time a key is used. The default setting is `On`.

```
>>Key Confirmation
? On
```

- 1 Press  $\triangleright$  while `>Buzzer >` is displayed.
- 2 Press  $\Delta$  or  $\nabla$  repeatedly until `>>Key Confirmation` appears.
- 3 Press **[OK]**. A blinking question mark (?) appears.

- 4 Select **On** or **Off** using  $\Delta$  or  $\nabla$ .
- 5 Press **[OK]**.
- 6 Press **[MENU]**. The display returns to *Ready*.

#### Job End (Job completed tone setting)

When **On** is selected in this setting, a tone sounds when printing ends. The default setting is *Off*.

- 1 Press  $\triangleright$  while *>Buzzer >* is displayed.
- 2 Press  $\Delta$  or  $\nabla$  repeatedly until *>>Job End* appears.
- 3 Press **[OK]**. A blinking question mark (?) appears.



- 4 Select **On** or **Off** using  $\Delta$  or  $\nabla$ .
- 5 Press **[OK]**.
- 6 Press **[MENU]**. The display returns to *Ready*.

#### Ready (Preparation completed tone setting)

When **On** is selected in this setting, a tone sounds when print preparation has been completed. The default setting is *Off*.

- 1 Press  $\triangleright$  while *>Buzzer >* is displayed.
- 2 Press  $\Delta$  or  $\nabla$  repeatedly until *>>Ready* appears.
- 3 Press **[OK]**. A blinking question mark (?) appears.



- 4 Select **On** or **Off** using  $\Delta$  or  $\nabla$ .
- 5 Press **[OK]**.
- 6 Press **[MENU]**. The display returns to *Ready*.

#### Error (Error tone setting)

When **On** is selected in this setting, a tone sounds when a problem such as running out of paper or a paper jam occurs during printing. The default setting is *On*.

- 1 Press  $\triangleright$  while *>Buzzer >* is displayed.
- 2 Press  $\Delta$  or  $\nabla$  repeatedly until *>>Error* appears.
- 3 Press **[OK]**. A blinking question mark (?) appears.



- 4 Select **On** or **Off** using  $\Delta$  or  $\nabla$ .
- 5 Press **[OK]**.
- 6 Press **[MENU]**. The display returns to *Ready*.

## RAM Disk Mode (Using the RAM disk)

The RAM disk is a memory space shared within the printer memory that can temporarily store print jobs. The stored print job can then be used to print multiple copies of the job reducing the total amount of time required to print the whole job. It acts similar to the SSD except that the data is effective only when the printer is powered up.

To use the RAM disk, activate and enter the desired size of the RAM disk in the manner described below. The maximum RAM disk size can be calculated as follows:

When the RAM disk is activated = The maximum RAM disk size is 32 MB (when no options are attached)

When the optional memory is installed = The maximum RAM disk size is 1/2 of the total optional memory installed

To activate RAM disk in the printer's memory, first you must set the RAM disk mode to `On` and set the desired data size for the RAM disk as described in the following section. This allows you to perform the following operations on the RAM disk.



**Note** The printer supports two types of storage device; optional SSD and RAM disk. The optional SSD is installed into the dedicated slot of the printer. The RAM disk is an allocated part of the printer's memory.

**IMPORTANT** The RAM disk can not be used when an optional SSD is installed.

The RAM disk stores data only temporarily. When the printer is reset or turned off, the stored data will be erased.

The RAM disk allows some Job Box functions to be used.

The RAM disk is allocated from the printer memory available to users. If the size of the RAM disk is set too large, the printing speed may decrease or the memory may become insufficient.

- 1 Press `▷` while `Device Common >` is displayed.
- 2 Press `△` or `▽` repeatedly until `>RAM Disk Mode >` appears.
- 3 Press **[OK]**. A blinking question mark (?) appears.
- 4 Select `On` or `Off` using `△` or `▽`.
- 5 Press **[OK]**.
- 6 Press **[MENU]**. The display returns to `Ready`.

```
>RAM Disk Mode >
? Off
```

## RAM Disk Size (Setting the RAM disk size)

Use this procedure to set the amount of memory used for the RAM disk.

**IMPORTANT** The RAM Disk Size menu option only appears when RAM Disk Mode is set to `On`.

- 1 Press `▷` while `>RAM Disk Mode On >` is displayed.
- 2 Press **[OK]**. The message display shows a blinking cursor (`_`). Press `△` or `▽` to display the desired size. Use `◀` and `▶` to move the cursor right and left.

This range varies depending on the total memory size of the printer.

```
>>RAM Disk Size
    032 MByte
```

- 3 When the desired RAM disk size is displayed, press **[OK]**.
- 4 Press **[MENU]**. The display returns to *Ready*. Turn the printer off and then on again. The selected RAM disk size is activated after the printer is restarted.

### SSD (Using the optional SSD)

Installing the optional SSD into the printer allows you to perform the following operations on the SSD.

- Format (Formatting SSD)

When an optional SSD is inserted into the printer for the first time, it must be formatted before use.

This menu is displayed only when the optional SSD is installed on the printer.

 **Note** If the optional SSD is installed in the printer, the Custom Box and Job Box will be available.

- 1 Press  $\triangleright$  while *Device Common >* is displayed.
- 2 Press  $\triangle$  or  $\nabla$  repeatedly until *>SSD >* appears.



### Format (Formatting SSD)

A new SSD must be formatted before it can be used in the printer. Formatting allows data to be written to the SSD.

This menu is displayed only when the optional SSD is installed on the printer.

 **Note** Formatting will destroy any existing data on a storage device including a used SSD. Formatting of the SSD must be executed from the printer.

Use the procedure below to format the SSD.

When a new SSD is inserted in the printer's slot, *Format SSD.* will appear on the message display.

- 1 Press  $\triangleright$  while *>SSD >* is displayed.
- 2 *>>Format* appears.
- 3 Press **[OK]**. A blinking question mark (?) appears.

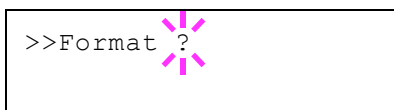

- 4 Press **[OK]** again.

*Processing* appears and formatting of the SSD starts. When the formatting is successfully completed, the display returns to *Ready*.

## Error Handling (Error detection setting)

This specifies the settings for the detection methods used for duplex printing errors and for paper size and paper type errors when the paper source is fixed.

The options available in Error Handling are as follows:

- Duplex (Duplex printing error detection setting)
- Paper Mismatch (Detection settings for paper size/type errors when the paper source is fixed)
- MP Tray Empty (Warning when the MP tray is empty)

**1** Press  $\triangleright$  while `Device Common >` is displayed.

**2** Press  $\triangle$  or  $\nabla$  repeatedly until `>Error Handling >` appears.

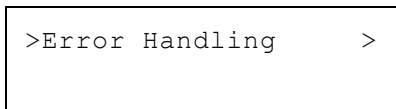

```
>Error Handling >
```

## Duplex (Duplex printing error detection setting)

If the error detection setting for duplex printing has been turned `On`, and you attempt to print onto a paper size and paper type that cannot be used for duplex printing, the `Duplex disabled Press GO` error message will be displayed and printing will stop.

<b>On</b>	<ul style="list-style-type: none"><li>• To print onto one-side of the paper only when this message is displayed, press <b>[GO]</b>.</li><li>• Press <b>[Cancel]</b> to cancel the printing itself.</li></ul>
<b>Off</b>	<ul style="list-style-type: none"><li>• To print onto one-side of the paper.</li></ul>

**1** Press  $\triangleright$  while `>Error Handling >` is displayed.

**2** Press  $\triangle$  or  $\nabla$  repeatedly until `>>Duplex` appears.

**3** Press **[OK]**. A blinking question mark (?) appears.

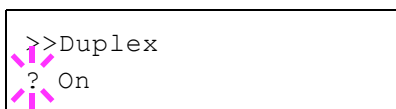

```
>>Duplex  
? On
```

**4** Select `On` or `Off` using  $\triangle$  or  $\nabla$ .

**5** Press **[OK]**.

**6** Press **[MENU]**. The display returns to `Ready`.

## Paper Mismatch (Detection settings for paper size/type errors when the paper source is fixed)

Turn this setting to `Off` if you want to continue printing even if the paper size or type you specified is different from the fixed paper source, or turn it to `On` to have the paper feed error displayed.

**1** Press  $\triangleright$  while `>Error Handling >` is displayed.

**2** Press  $\triangle$  or  $\nabla$  repeatedly until `>>Paper Mismatch` appears.

**3** Press **[OK]**. A blinking question mark (?) appears.

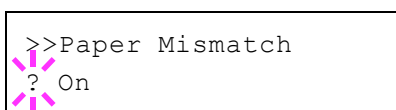

```
>>Paper Mismatch  
? On
```

**4** Select `On` or `Off` using  $\triangle$  or  $\nabla$ .

**5** Press **[OK]**.

6 Press **[MENU]**. The display returns to *Ready*.

### MP Tray Empty (Warning when the MP tray is empty)

Turn this setting to *On* if you want the error displayed when the MP tray is configured as the default paper source, and there is no paper in the MP tray, or turn it to *Off* not to have the error displayed.

The setting *On* enables the paper-empty message to display when the MP tray is empty.

- 1 Press  $\triangleright$  while *>Error Handling >* is displayed.
- 2 Press  $\triangle$  or  $\nabla$  repeatedly until *>>MP Tray Empty* appears.
- 3 Press **[OK]**. A blinking question mark (?) appears.

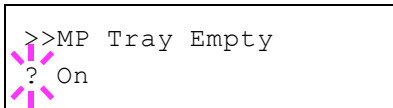

- 4 Select *On* or *Off* using  $\triangle$  or  $\nabla$ .
- 5 Press **[OK]**.
- 6 Press **[MENU]**. The display returns to *Ready*.

### Timer (Timer setting)

This specifies timer-related settings such as the automatic form-feed timeout and the timeout settings for Sleep timer.

The options available in Timer are as follows:

- ID (Administrator ID input)
- Password (Administrator Password input)
- Auto Panel Reset (Auto panel reset settings)
- Panel Reset Timer (Setting the panel reset timer)
- Low Power Timer (Low Power Mode timer timeout time)
- Sleep Timer (Sleep timer timeout time)
- Auto Error Clear (Auto error clear setting)
- Error Clear Timer (Setting the error clear time)
- Form Feed Time Out (Automatic form feed timeout setting)

- 1 Press  $\triangleright$  while *Device Common >* is displayed.
- 2 Press  $\triangle$  or  $\nabla$  repeatedly until *>Timer >* appears.



### ID (Administrator ID input)

To use the Timer settings, you must enter an administrator ID. For information on how to set the administrator ID, refer to *Administrator (Administrator settings) on page 2-94*.

- 1 Press  $\triangleright$  while *>Timer >* is displayed.
- 2 The message display shows *ID* and a blinking cursor ( $\_$ ).



- 3 Press  $\Delta$  or  $\nabla$  to increase or decrease, respectively, the value at the blinking cursor. Enter the specified ID. Use  $\triangleleft$  and  $\triangleright$  to move the cursor right and left. Enter an ID consisting of between 1 and 16 numbers.
- 4 Press **[OK]**. Proceed to the next step *Password (Administrator Password input)*.

### Password (Administrator Password input)

To set up the Timer settings, you must enter an administrator ID and administrator password. For information on how to set the administrator password, refer to *Administrator (Administrator settings)* on page 2-94.



- 1 Once you have entered the correct ID in the previous step (ID (Administrator ID input)), the message display shows `Password` (Administrator password input) and a blinking cursor (`_`).
- 2 Press  $\Delta$  or  $\nabla$  to increase or decrease, respectively, the value at the blinking cursor. Enter the specified password. Use  $\triangleleft$  and  $\triangleright$  to move the cursor right and left. Enter a password consisting of between 0 (no settings) and 16 numbers.



**Note** If you enter the incorrect administrator ID or password, the message `Wrong ID` or `Wrong Password` appears and the input screen then reappears. Re-enter the ID or password correctly.

- 3 Press **[OK]**. The Timer settings screen appears.

### Auto Panel Reset (Auto panel reset settings)

The Auto Panel Reset function automatically restores the default settings if the panel is not used for a set time. The default setting is `On`.

For setting the time until the panel is reset, refer to the next section *Panel Reset Timer (Setting the panel reset timer)*.

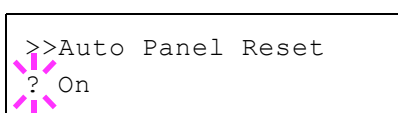

- 1 After entering the administrator ID and password, press  $\Delta$  or  $\nabla$  repeatedly until `>>Auto Panel Reset` appears.
- 2 Press **[OK]**. A blinking question mark (?) appears.

- 3 Select `On` or `Off` using  $\Delta$  or  $\nabla$ .

- 4 Press **[OK]**.

- 5 Press **[MENU]**. The display returns to `Ready`.

### Panel Reset Timer (Setting the panel reset timer)

When Auto Panel Reset is set to `On`, this sets the time until the panel is automatically reset after the user stops using the panel.

- 1 After entering the administrator ID and password, press  $\Delta$  or  $\nabla$  repeatedly until `>>Panel Reset Timer` appears.
- 2 Press **[OK]**. The message display shows a blinking cursor (`_`).

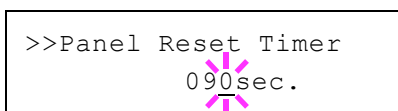

- 3 Press  $\Delta$  or  $\nabla$  to increase or decrease the value at the blinking cursor and set the desired time. The time must be set between 005 and 495 seconds, in 5-second increments. Use  $\triangleleft$  and  $\triangleright$  to move the cursor right and left.
- 4 Press **[OK]**.
- 5 Press **[MENU]**. The display returns to *Ready*.

#### Low Power Timer (Low Power Mode timer timeout time)

You can adjust the length of time the printer waits before entering Low Power Mode in the absence of a print job.

The printer reverts to normal operation mode when the printer receives a print job or **[GO]** is pressed on the operation panel. The default time is 1 minute.

- 1 After entering the administrator ID and password, press  $\Delta$  or  $\nabla$  repeatedly until `>>Low Power Timer` appears.
- 2 To change the timeout time, press **[OK]**. A blinking cursor (  ) appears.

```
>>Low Power Timer
   005 min.
```

- 3 Press  $\Delta$  or  $\nabla$  to increase or decrease the value at the blinking cursor and set the desired time. The timer can be set between 1 and 60 min. Use  $\triangleleft$  and  $\triangleright$  to move the cursor right and left.
- 4 Press **[OK]**.
- 5 Press **[MENU]**. The display returns to *Ready*.

#### Sleep Timer (Sleep timer timeout time)

You can adjust the length of time the printer waits before entering Auto Sleep in the absence of data.

The printer reverts to normal operation mode when the printer receives a print job or **[GO]** is pressed on the operation panel. The default time is 15 minutes.

 **Note** Color calibration is automatically executed before the printer reverts to normal operation mode.

- 1 After entering the administrator ID and password, press  $\Delta$  or  $\nabla$  repeatedly until `>>Sleep Timer` appears.
- 2 To change the timeout time, press **[OK]**. A blinking cursor (  ) appears.

```
>>Sleep Timer
   015 min.
```

- 3 Press  $\Delta$  or  $\nabla$  to increase or decrease the value at the blinking cursor and set the desired time. The timer can be set between 1 and 60 min (for Europe) or 1 and 240 min (except for Europe). Use  $\triangleleft$  and  $\triangleright$  to move the cursor right and left.
- 4 Press **[OK]**.
- 5 Press **[MENU]**. The display returns to *Ready*.



---

### Auto Error Clear (Auto error clear setting)

If an error that still allows you to continue printing occurs, the next received data is automatically printed after a set period of time elapses. For example, if the printer is shared over a network as a network printer and one person causes one of the above errors, after the set period of time elapses, the data sent from the next person is printed. The default setting is `Off` (Auto Error Clear disabled).

The auto clear errors are:

- Memory overflow Press GO
- KPDL error ## Press GO
- SSD error ## Press GO
- RAM disk error## Press GO
- Illegal Account Press GO
- Exceeded Max.out Press GO
- Job restricted Press GO
- Account error ## Press GO
- Duplex disabled Press GO
- Job not stored Press GO
- No multi copies Press GO
- USB memory error ## Press GO

For setting the auto error clear recovery time, refer to the next section *Error Clear Timer (Setting the error clear time)*.

- 1 After entering the administrator ID and password, press  $\Delta$  or  $\nabla$  repeatedly until `>>Auto Error Clear` appears.
- 2 Press **[OK]**. A blinking question mark (?) appears.

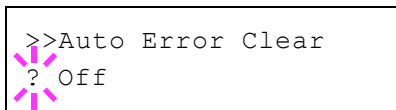

```
>>Auto Error Clear
? Off
```

- 3 Select `On` or `Off` using  $\Delta$  or  $\nabla$ .
- 4 Press **[OK]**.
- 5 Press **[MENU]**. The display returns to `Ready`.

### Error Clear Timer (Setting the error clear time)

If Auto Error Clear is set to `On` and a non-fatal error (an error that allows printing to continue) occurs, this setting specifies the time until the error is recovered and printing resumes.

- 1 After entering the administrator ID and password, press  $\Delta$  or  $\nabla$  repeatedly until `>>Error Clear Timer` appears.
- 2 Press **[OK]**. A blinking cursor (`_`) appears.

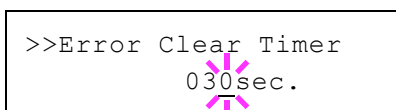

```
>>Error Clear Timer
030sec.
```

- 3 Press  $\Delta$  or  $\nabla$  to increase or decrease the value at the blinking cursor and set the desired time. The time must be set between `005` and `495` seconds, in 5-second increments. You can use  $\triangleleft$  and  $\triangleright$  to move the cursor right and left.
- 4 Press **[OK]**.
- 5 Press **[MENU]**. The display returns to `Ready`.

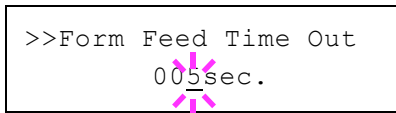

### Form Feed Time Out (Automatic form feed timeout setting)

If the printer receives no data for a certain period, it will time out and release the current interface. It prints whatever data it has in its buffer and feeds out the page. The default form feed timeout time is 30 seconds.

- 1 After entering the administrator ID and password, press  $\Delta$  or  $\nabla$  repeatedly until >>Form Feed Time Out appears.
- 2 Press **[OK]**. A blinking cursor (  $\_$  ) appears.
- 3 Press  $\Delta$  or  $\nabla$  to increase or decrease the value at the blinking cursor and set the desired time. The timeout time can be between 5 and 495 seconds, in 5-second increments. Use  $\triangleleft$  and  $\triangleright$  to move the cursor right and left.
- 4 Press **[OK]**.
- 5 Press **[MENU]**. The display returns to Ready.

### Sleep Level Set. (Sleep level setting)

#### For Europe

This sets whether or not the machine enters sleep mode when connected to a network.

- ID (Administrator ID input)
- Password (Administrator Password input)
- Network (Setting for entering sleep mode when connected to a network)

- 1 Press  $\triangleright$  while Device Common > is displayed.
- 2 Press  $\Delta$  or  $\nabla$  repeatedly until >Sleep Level Set. > appears.

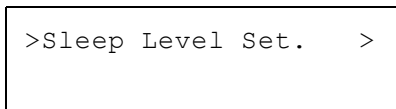

#### ID (Administrator ID input)

To use the Sleep Level settings, you must enter an administrator ID. For information on how to set the administrator ID, refer to *Administrator (Administrator settings) on page 2-94*.

- 1 Press  $\triangleright$  while >Sleep Level Set. > is displayed.
- 2 The message display shows ID and a blinking cursor (  $\_$  ).
- 3 Press  $\Delta$  or  $\nabla$  to increase or decrease, respectively, the value at the blinking cursor. Enter the specified ID. Use  $\triangleleft$  and  $\triangleright$  to move the cursor right and left. Enter an ID consisting of between 1 and 16 numbers.
- 4 Press **[OK]**. Proceed to the next step *Password (Administrator Password input)*.



### Password (Administrator Password input)

To set up the Sleep Level settings, you must enter an administrator ID and administrator password. For information on how to set the administrator password, refer to *Administrator (Administrator settings) on page 2-94*.



- 1 Once you have entered the correct ID in the previous step (ID (Administrator ID input)), the message display shows `Password` (Administrator password input) and a blinking cursor (`_`).
- 2 Press  $\Delta$  or  $\nabla$  to increase or decrease, respectively, the value at the blinking cursor. Enter the specified password. Use  $\triangleleft$  and  $\triangleright$  to move the cursor right and left. Enter a password consisting of between 0 (no settings) and 16 numbers.



**Note** If you enter the incorrect administrator ID or password, the message `Wrong ID` or `Wrong Password` appears and the input screen then reappears. Re-enter the ID or password correctly.

- 3 Press **[OK]**. The Sleep Level settings screen appears.

### Network (Setting for entering sleep mode when connected to a network)

This sets whether or not the machine enters sleep mode when connected to a network.

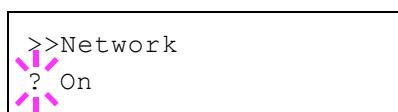

- 1 After entering the administrator ID and password, press  $\Delta$  or  $\nabla$  repeatedly until `>>Network` appears.
- 2 Press **[OK]**. A blinking question mark (?) appears.

- 3 Select `On` or `Off` using  $\Delta$  or  $\nabla$ .
- 4 Press **[OK]**.
- 5 Press **[MENU]**. The display returns to `Ready`.

### Except for Europe

Select the sleep level.

The options available in Sleep Level Set. are as follows:

- ID (Administrator ID input)
- Password (Administrator Password input)
- Sleep Level (Sleep level setting)
- Network (Setting for entering energy-saving mode when connected to a network)



**Note** `Network` is only displayed when `Sleep Level` is set to `Energy Saver`.

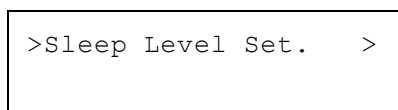

- 1 Press  $\triangleright$  while `Device Common >` is displayed.
- 2 Press  $\Delta$  or  $\nabla$  repeatedly until `>Sleep Level Set. >` appears.

### **ID (Administrator ID input)**

To use the Sleep Level settings, you must enter an administrator ID. For information on how to set the administrator ID, refer to *Administrator (Administrator settings) on page 2-94*.



- 1 Press  $\triangleright$  while `>Sleep Level Set. >` is displayed.
- 2 The message display shows `ID` and a blinking cursor (`_`).
- 3 Press  $\triangle$  or  $\nabla$  to increase or decrease, respectively, the value at the blinking cursor. Enter the specified ID. Use  $\triangleleft$  and  $\triangleright$  to move the cursor right and left. Enter an ID consisting of between 1 and 16 numbers.
- 4 Press **[OK]**. Proceed to the next step *Password (Administrator Password input)*.

### **Password (Administrator Password input)**

To set up the Sleep Level settings, you must enter an administrator ID and administrator password. For information on how to set the administrator password, refer to *Administrator (Administrator settings) on page 2-94*.

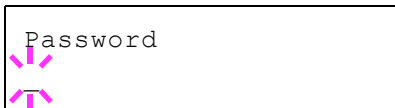

- 1 Once you have entered the correct ID in the previous step (ID (Administrator ID input)), the message display shows `Password` (Administrator password input) and a blinking cursor (`_`).
- 2 Press  $\triangle$  or  $\nabla$  to increase or decrease, respectively, the value at the blinking cursor. Enter the specified password. Use  $\triangleleft$  and  $\triangleright$  to move the cursor right and left. Enter a password consisting of between 0 (no settings) and 16 numbers.



**Note** If you enter the incorrect administrator ID or password, the message `Wrong ID` or `Wrong Password` appears and the input screen then reappears. Re-enter the ID or password correctly.

- 3 Press **[OK]**. The Sleep Level settings screen appears.

### **Sleep Level (Sleep level setting)**

There are two sleep modes with different levels of sleep: Quick Recovery and Energy Saver.

**Quick Recovery Mode:** The recovery from the sleep mode is faster than when using Energy Saver mode.

**Energy Saver Mode:** This makes it possible to reduce energy consumption even further than with Quick Recovery mode. With Energy Saver mode, you can set whether to enable the Energy Saver mode for each separate function.



**Note** For information on the Quick Recovery mode and Energy Saver mode, refer to *Printing Operation* section in the *Operation Guide*.

Sleep Level Set. menu is not displayed when the optional network interface kit (IB-50) or wireless network interface kit (IB-51) has been installed.

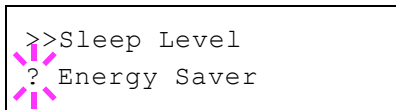

- 1 After entering the administrator ID and password, press  $\Delta$  or  $\nabla$  repeatedly until `>>Sleep Level` appears.
- 2 Press **[OK]**. A blinking question mark (?) appears.
- 3 Press  $\Delta$  or  $\nabla$  to select `Quick Recovery` or `Energy Saver`.
- 4 Press **[OK]**.
- 5 Press **[MENU]**. The display returns to `Ready`.

***Network (Setting for entering energy-saving mode when connected to a network)***

This sets whether or not the machine enters Energy Saver mode when connected to a network.

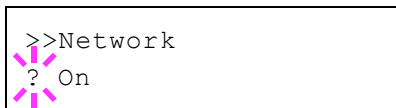

- 1 After entering the administrator ID and password, press  $\Delta$  or  $\nabla$  repeatedly until `>>Network` appears.
- 2 Press **[OK]**. A blinking question mark (?) appears.
- 3 Select `On` or `Off` using  $\Delta$  or  $\nabla$ .
- 4 Press **[OK]**.
- 5 Press **[MENU]**. The display returns to `Ready`.

---

## TonerAlert Level (Setting for the alert level for toner addition)

This sets the toner addition alert level displayed on the status monitor.

The options available in TonerAlert Level are as follows:

- ID (Administrator ID input)
- Password (Administrator Password input)
- Off/On
- TonerAlert Level (Setting for the alert level for toner addition)

- 1** Press  $\triangleright$  while `Device Common >` is displayed.
- 2** Press  $\triangle$  or  $\nabla$  repeatedly until `>TonerAlert Level >` appears.

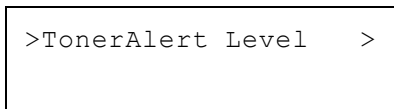

### ID (Administrator ID input)

To use the TonerAlert Level settings, you must enter an administrator ID. For information on how to set the administrator ID, refer to *Administrator (Administrator settings) on page 2-94*.

- 1** Press  $\triangleright$  while `>TonerAlert Level >` is displayed.
- 2** The message display shows `ID` and a blinking cursor (`_`).



- 3** Press  $\triangle$  or  $\nabla$  to increase or decrease, respectively, the value at the blinking cursor. Enter the specified ID. Use  $\triangleleft$  and  $\triangleright$  to move the cursor right and left. Enter an ID consisting of between 1 and 16 numbers.
- 4** Press **[OK]**. Proceed to the next step *Password (Administrator Password input)*.

### Password (Administrator Password input)

To set up the TonerAlert Level settings, you must enter an administrator ID and administrator password. For information on how to set the administrator password, refer to *Administrator (Administrator settings) on page 2-94*.

- 1** Once you have entered the correct ID in the previous step (ID (Administrator ID input)), the message display shows `Password` (Administrator password input) and a blinking cursor (`_`).
- 2** Press  $\triangle$  or  $\nabla$  to increase or decrease, respectively, the value at the blinking cursor. Enter the specified password. Use  $\triangleleft$  and  $\triangleright$  to move the cursor right and left. Enter a password consisting of between 0 (no settings) and 16 numbers.



**Note** If you enter the incorrect administrator ID or password, the message `Wrong ID` or `Wrong Password` appears and the input screen then reappears. Re-enter the ID or password correctly.

- 3** Press **[OK]**. The TonerAlert Level settings screen appears.

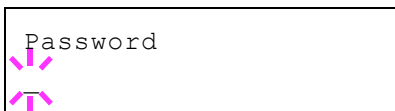

---

### Off/On (Setting toner addition notifications)

Select whether Toner Alert Level is enabled.

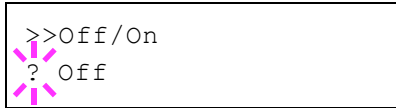

```
>>Off/On
? Off
```

- 1 After entering the administrator ID and password, press  $\Delta$  or  $\nabla$  repeatedly until `>>Off/On` appears.
- 2 Press **[OK]**. A blinking question mark (?) appears.
- 3 Select `On` or `Off` using  $\Delta$  or  $\nabla$ .
- 4 Press **[OK]**.
- 5 Press **[MENU]**. The display returns to `Ready`.

### TonerAlert Level (Setting for the alert level for toner addition)

This sets the level at which toner addition alerts will be displayed.

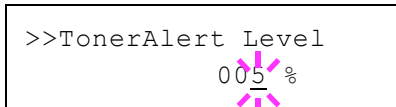

```
>>TonerAlert Level
005%
```

- 1 After entering the administrator ID and password, press  $\Delta$  or  $\nabla$  repeatedly until `>>TonerAlert Level` appears.
- 2 Press **[OK]**. A blinking cursor ( `_` ) appears.
- 3 Press  $\Delta$  or  $\nabla$  to increase or decrease the value at the blinking cursor and set the level at which an alert will be displayed. The setting is possible between `005` and `100%`. Use  $\triangleleft$  and  $\triangleright$  to move the cursor right and left.
- 4 Press **[OK]**.
- 5 Press **[MENU]**. The display returns to `Ready`.

---

## Security

The security functions can be set up to protect printer operation and the print data.

The options available in Security are as follows:

- ID (Administrator ID input)
- Password (Administrator Password input)
- I/F Block (Interface (external device) block setting)
- WSD-PRINT (WSD-PRINT setting)
- Enhanced WSD (Enhanced WSD setting)
- EnhancedWSD(SSL) (Enhanced WSD (SSL) setting)
- IPP (IPP setting)
- SSL Server (SSL Server setting)
- IPsec (IPsec setting)
- LAN Interface (LAN Interface setting)
- Security Level (Security Level setting)



**Note** When Embedded Web Server RX is used, network parameters and security settings can be conveniently changed and checked from your PC. For more information, refer to the *Embedded Web Server RX User Guide*.

- 1 Press **[MENU]**.
- 2 Press  $\Delta$  or  $\nabla$  repeatedly until `Security >` appears.

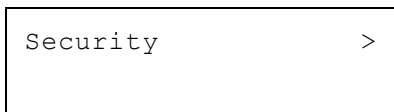

### ID (Administrator ID input)

To use the Security function, you must enter an administrator ID. For information on how to set the administrator ID, refer to *Administrator (Administrator settings) on page 2-94*.

- 1 Press  $\triangleright$  while `Security >` is displayed.
- 2 The message display shows `ID` and a blinking cursor (`_`).



- 3 Press  $\Delta$  or  $\nabla$  to increase or decrease, respectively, the value at the blinking cursor. Enter the specified ID. Use  $\triangleleft$  and  $\triangleright$  to move the cursor right and left. Enter an ID consisting of between 1 and 16 numbers.
- 4 Press **[OK]**. Proceed to the next step *Password (Administrator Password input)*.

### Password (Administrator Password input)

To set up the Security functions, you must enter an administrator ID and administrator password. For information on how to set the administrator password, refer to *Administrator (Administrator settings) on page 2-94*.

- 1 Once you have entered the correct ID in the previous step (ID (Administrator ID input)), the message display shows `Password` (Administrator password input) and a blinking cursor (`_`).

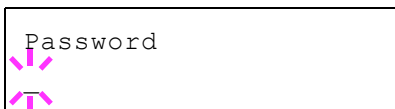



- 2 Press  $\Delta$  or  $\nabla$  to increase or decrease, respectively, the value at the blinking cursor. Enter the specified password. Use  $\triangleleft$  and  $\triangleright$  to move the cursor right and left. Enter a password consisting of between 0 (no settings) and 16 numbers.



**Note** If you enter the incorrect administrator ID or password, the message `Wrong ID` or `Wrong Password` appears and the input screen then reappears. Re-enter the ID or password correctly.

- 3 Press **[OK]**. The Security screen appears.

### I/F Block (Interface (external device) block setting)

You can use this to lock and thereby protect the interface. The options available in Interface Block are as follows:

- USB Host (USB memory slot setting)
- USB Device (USB interface setting)
- Option I/F (Network interface card setting)
- USB Storage (USB memory setting)

```
>I/F Block >
```

- 1 After entering the administrator ID and password, press  $\Delta$  or  $\nabla$  repeatedly until `>I/F Block >` appears.

### USB Host (USB memory slot setting)

This locks and protects the USB memory slot (USB host). The default setting is `Unblock`.

```
>>USB Host  
? Unblock
```

- 1 Press  $\triangleright$  while `>I/F Block >` is displayed.
- 2 Press  $\Delta$  or  $\nabla$  repeatedly until `>>USB Host` appears.
- 3 Press **[OK]**. A blinking question mark (?) appears.

- 4 Select `Block` or `Unblock` using  $\Delta$  or  $\nabla$ .

- 5 Press **[OK]**.

- 6 Press **[MENU]**. The display returns to `Ready`.

### USB Device (USB interface setting)

This locks and protects the USB interface. The default setting is `Unblock`.

```
>>USB Device  
? Unblock
```

- 1 Press  $\triangleright$  while `>I/F Block >` is displayed.

- 2 Press  $\Delta$  or  $\nabla$  repeatedly until `>>USB Device` appears.

- 3 Press **[OK]**. A blinking question mark (?) appears.

- 4 Select `Block` or `Unblock` using  $\Delta$  or  $\nabla$ .

- 5 Press **[OK]**.

- 6 Press **[MENU]**. The display returns to `Ready`.

---

### Option I/F (Network interface card setting)

This locks and protects the network interface card (NIC). The default setting is Unblock.

 **Note** Option I/F is displayed only when the optional network interface is installed on the printer.

- 1 Press  $\triangleright$  while  $>I/F$  Block  $>$  is displayed.
- 2 Press  $\triangle$  or  $\nabla$  repeatedly until  $>>Option$  I/F appears.
- 3 Press **[OK]**. A blinking question mark (?) appears.

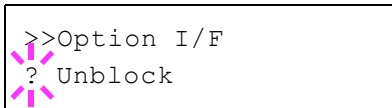

```
>>Option I/F
? Unblock
```

- 4 Select Block or Unblock using  $\triangle$  or  $\nabla$ .
- 5 Press **[OK]**.
- 6 Press **[MENU]**. The display returns to Ready.

### USB Storage (USB memory setting)

This blocks and protects the USB storage (USB memory). The default setting is Unblock.

- 1 Press  $\triangleright$  while  $>I/F$  Block  $>$  is displayed.
- 2 Press  $\triangle$  or  $\nabla$  repeatedly until  $>>USB$  Storage appears.
- 3 Press **[OK]**. A blinking question mark (?) appears.

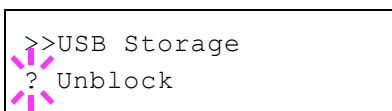

```
>>USB Storage
? Unblock
```

- 4 Select Block or Unblock using  $\triangle$  or  $\nabla$ .
- 5 Press **[OK]**.
- 6 Press **[MENU]**. The display returns to Ready.

### WSD-PRINT (WSD-PRINT setting)

Select whether or not to use WSD Print. The default setting is On.

- 1 After entering the administrator ID and password, press  $\triangle$  or  $\nabla$  repeatedly until  $>WSD-PRINT$  appears.
- 2 Press **[OK]**. A blinking question mark (?) appears.

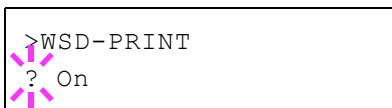

```
>WSD-PRINT
? On
```

- 3 Press  $\triangle$  or  $\nabla$  to select whether WSD-PRINT is enabled.
- 4 Press **[OK]**.
- 5 Press **[MENU]**. The display returns to Ready.

### Enhanced WSD (Enhanced WSD setting)

Set whether to use our proprietary web services. Network driver use this Enhanced WSD Web service. The default setting is On.

- 1 After entering the administrator ID and password, press  $\triangle$  or  $\nabla$  repeatedly until  $>Enhanced$  WSD appears.

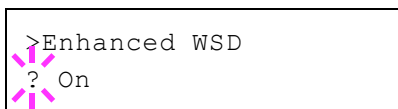

**2** Press **[OK]**. A blinking question mark (?) appears.

**3** Press  $\Delta$  or  $\nabla$  to select whether Enhanced WSD is enabled.

**4** Press **[OK]**.

**5** Press **[MENU]**. The display returns to *Ready*.

### EnhancedWSD(SSL) (Enhanced WSD (SSL) setting)

Set whether to use our proprietary web services over SSL. SSL must be set to *On* in *SSL Server (SSL Server setting)* on page 2-83. The default setting is *On*.

**1** After entering the administrator ID and password, press  $\Delta$  or  $\nabla$  repeatedly until *>EnhancedWSD(SSL)* appears.

**2** Press **[OK]**. A blinking question mark (?) appears.

**3** Press  $\Delta$  or  $\nabla$  to select whether Enhanced WSD (SSL) is enabled.

**4** Press **[OK]**.

**5** Press **[MENU]**. The display returns to *Ready*.

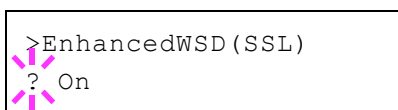

### IPP (IPP setting)

IPP (Internet Printing Protocol) is a standard that uses TCP/IP networks such as the Internet to enable print jobs to be sent between remote computers and printers.

IPP is an extension of the HTTP protocol used to view websites and enables printing to be carried out via routers on printers in remote locations. It also supports the HTTP authentication mechanisms along with SSL server and client authentication as well as encryption.

The default setting is *On*.



**Note** Check with your network administrator when selecting network settings.



**1** After entering the administrator ID and password, press  $\Delta$  or  $\nabla$  repeatedly until *>IPP* appears.

**2** Press **[OK]**. A blinking question mark (?) appears.



**3** Select *On* or *Off* using  $\Delta$  or  $\nabla$ .

**4** Press **[OK]**.

**5** Press **[MENU]**. The display returns to *Ready*.

---

## SSL Server (SSL Server setting)

SSL (Secure Sockets Layer) refers to a protocol used to encrypt information sent and received over a network. SSL can currently be used to encrypt data such as the WWW or FTP files widely used on the Internet so that privacy-related information, credit card numbers, corporate secrets and other confidential information can be sent and received safely.

SSL servers use this protocol to authenticate servers and clients.

The default setting is *Off*.



**Note** Check with your network administrator when selecting network settings.

```
>SSL Server >
```

```
>SSL Server >  
? Off
```

- 1 After entering the administrator ID and password, press  $\Delta$  or  $\nabla$  repeatedly until `>SSL Server >` appears.
- 2 Press **[OK]**. A blinking question mark (?) appears.
- 3 Select *On* or *Off* using  $\Delta$  or  $\nabla$ .
- 4 Press **[OK]**.
- 5 Press **[MENU]**. The display returns to *Ready*.

## DES (SSL Server DES setting)

DES (Data Encryption Standard) is a typical symmetric-key cryptographic algorithm that divides data in to 64-bit blocks and then encrypts each block using a 56-bit key.



**Note** Symmetric-key cryptography, because it uses the same key for both encryption and decryption, uses the same key in both directions when encrypted data is exchanged. Accordingly, to prevent the key from being divulged, key transfer and storage must be very strictly managed.

The default setting is *Off*.

```
>>DES  
? Off
```

- 1 Press  $\triangleright$  while `>SSL Server On >` is displayed. `>>DES` appears.
- 2 Press **[OK]**. A blinking question mark (?) appears.
- 3 Select *On* or *Off* using  $\Delta$  or  $\nabla$ .
- 4 Press **[OK]**.
- 5 Press **[MENU]**. The display returns to *Ready*.

### 3DES (SSL Server 3DES setting)

3DES (Triple Data Encryption Standard) is a high level of encryption in which DES encryption is repeated threefold.

The default setting is *Off*.



**1** Press  $\triangleright$  while `>SSL Server On >` is displayed. `>>3DES` appears.

**2** Press **[OK]**. A blinking question mark (?) appears.

**3** Select *On* or *Off* using  $\triangle$  or  $\nabla$ .

**4** Press **[OK]**.

**5** Press **[MENU]**. The display returns to *Ready*.

### AES (SSL Server AES setting)

AES (Advanced Encryption Standard) was developed to replace DES as the standard encryption as the safety of DES has declined. AES is a block encryption system that uses 128-bit blocks and an SPN structure (a typical structure for repeated encryption) with three selectable key lengths of 128, 192 and 256 bits.

The default setting is *Off*.



**1** Press  $\triangleright$  while `>SSL Server On >` is displayed. `>>AES` appears.

**2** Press **[OK]**. A blinking question mark (?) appears.

**3** Select *On* or *Off* using  $\triangle$  or  $\nabla$ .

**4** Press **[OK]**.

**5** Press **[MENU]**. The display returns to *Ready*.

### IPP over SSL (SSL Server IPP over SSL setting)

IPP over SSL is an encryption function that uses SSL for communications between users and servers in network printing. To use IPP over SSL, both server and client must support the protocol.

The default setting is *Off*.

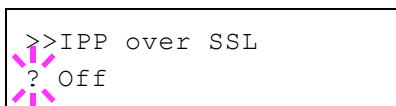

**1** Press  $\triangleright$  while `>SSL Server On >` is displayed. `>>IPP over SSL` appears.

**2** Press **[OK]**. A blinking question mark (?) appears.

**3** Select *On* or *Off* using  $\triangle$  or  $\nabla$ .

**4** Press **[OK]**.

**5** Press **[MENU]**. The display returns to *Ready*.

### HTTPS (SSL Server HTTPS setting)

HTTPS (HyperText Transfer Protocol Secure) is a protocol that adds SSL data encryption, message authentication and a digital signature function to the HTTP protocol used for data transfer between WWW servers and clients.

S-HTTP is a similar protocol, but HTTPS differs in that it uses SSL.

The default setting is *Off*.

- 1 Press  $\triangleright$  while `>SSL Server On >` is displayed. `>>HTTPS` appears.
- 2 Press **[OK]**. A blinking question mark (?) appears.



- 3 Select *On* or *Off* using  $\triangle$  or  $\nabla$ .
- 4 Press **[OK]**.
- 5 Press **[MENU]**. The display returns to *Ready*.

### IPSec (IPSec setting)

IPSec (IP Security Protocol) is a security protocol adopted as the standard by the IETF for authentication and encryption in the third network layer (IP layer).

It can be used with both IPv4 and IPv6.

 **Note** IPv4 uses 32-bit IP addresses and IPv6 uses 128-bit IP addresses.

The default setting is *Off*.

 **Note** Check with your network administrator when selecting network settings.

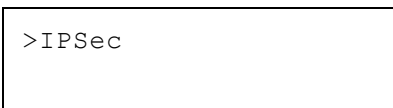

- 1 After entering the administrator ID and password, press  $\triangle$  or  $\nabla$  repeatedly until `>IPSec` appears.
- 2 Press **[OK]**. A blinking question mark (?) appears.
- 3 Select *On* or *Off* using  $\triangle$  or  $\nabla$ .
- 4 Press **[OK]**.
- 5 Press **[Menu]**. The display returns to *Ready*.

---

## LAN Interface (LAN Interface setting)

Specify the settings for the LAN interface to be used. The default setting is `Auto`.

```
>LAN Interface
  Auto
```

```
>LAN Interface
? Auto
```

**1** After entering the administrator ID and password, press  $\triangle$  or  $\nabla$  repeatedly until `>LAN Interface` appears.

**2** Press **[OK]**. A blinking question mark (?) appears.

**3** Press  $\triangle$  or  $\nabla$  to select the desired LAN Interface. The available LAN Interfaces are as follows:

```
Auto
10Base-Half
10Base-Full
100Base-Half
100Base-Full
1000Base-T
```

**4** Press **[OK]**.

**5** Press **[MENU]**. The display returns to `Ready`.

## Security Level (Security Level setting)

`Security Level` is primarily a menu used by service personnel for maintenance work. There is no need for customers to use this menu.

---

## Job Accounting (Job Accounting selection/setting)

Job Accounting is a function that allows the number of pages used to be managed by each department to be managed through the use of entered account IDs.

Job accounting on this machine offers the following features:

- Support for up to 100 departments
- Department codes up to 8 digits long from 1 to 99999999
- Collective print management for the same department code
- Totaling of the number of pages used for each department
- Specifiable limits (1 to 9,999,999) on the number of pages used
- Resetting of the number of pages used for individual departments

The options available in Job Accounting are as follows:

- ID (Administrator ID input)
- Password (Administrator Password input)
- Job Accounting (Job Accounting selection/setting)
- Select Account (Department-specific settings)
- Add Account (Department registration)
- Delete Account (Department removal)
- Print Job Accounting List (Job Accounting list output)
- Apply Limit (Operation settings when limits are exceeded)
- Unknown ID Job (Operation settings for unknown account IDs)

**IMPORTANT** `Select Account` and `Delete Account` are only displayed if one or more department codes have been registered. Also, `Add Account` is not displayed if the number of registered accounts has already reached the permitted maximum.

- 1 Press **[MENU]**.
- 2 Press  $\Delta$  or  $\nabla$  repeatedly until `Job Accounting >` appears.

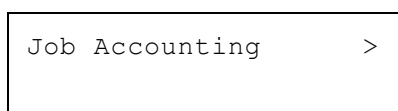

### ID (Administrator ID input)

To set up Job Accounting, you must enter an administrator ID. For information on how to set the administrator ID, refer to *Administrator (Administrator settings) on page 2-94*.

- 1 Press  $\triangleright$  while `Job Accounting >` is displayed.
- 2 The message display shows `ID` and a blinking cursor (`_`).



- 3 Press  $\Delta$  or  $\nabla$  to increase or decrease, respectively, the value at the blinking cursor. Enter the specified ID. Use  $\triangleleft$  and  $\triangleright$  to move the cursor right and left. Enter an ID consisting of between 1 and 16 numbers.
- 4 Press **[OK]**. Proceed to the next step *Password (Administrator Password input)*.



---

## Password (Administrator Password input)

To set up Job Accounting, you must enter an administrator ID and administrator password. For information on how to set the administrator password, refer to *Administrator (Administrator settings) on page 2-94*.

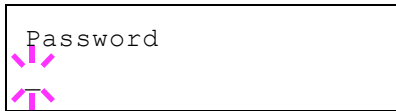

**1** Once you have entered the correct ID in the previous step (ID (Administrator ID input)), the message display shows `Password` (Administrator password input) and a blinking cursor (`_`).

**2** Press  $\Delta$  or  $\nabla$  to increase or decrease, respectively, the value at the blinking cursor. Enter the specified password. Use  $\triangleleft$  and  $\triangleright$  to move the cursor right and left. Enter a password consisting of between 0 and 16 numbers.



**Note** If you enter the incorrect administrator ID or password, the message `Wrong ID` or `Wrong Password` appears and the input screen then reappears. Re-enter the ID or password correctly.

**3** Press **[OK]**. The Job Accounting selection/setting screen reappears.

## Job Accounting (Job Accounting selection/setting)

This allows you to turn the Job Accounting function `On` and `Off`. The default setting is `Off`.

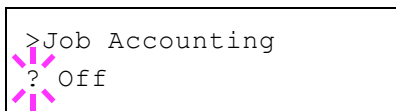

**1** After entering the administrator ID and password, press  $\Delta$  or  $\nabla$  repeatedly until `>Job Accounting` appears.

**2** Press **[OK]**. A blinking question mark (?) appears.

**3** Select `On` or `Off` using  $\Delta$  or  $\nabla$ .

**4** Press **[OK]**.

**5** Press **[MENU]**. The display returns to `Ready`.

## Job Accounting Enabled

If department administration is enabled, an account ID entry screen appears each time you retrieve a status page or list.

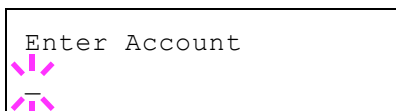

**1** A blinking cursor (`_`) appears in the account ID entry screen.

**2** Press  $\Delta$  or  $\nabla$  to increase or decrease, respectively, the value at the blinking cursor. Enter the specified account ID. Use  $\triangleleft$  and  $\triangleright$  to move the cursor right and left. Enter an account ID consisting of between 1 and 8 numbers.



**Note** If you enter an incorrect account ID, the input screen reappears. Re-enter the account ID correctly.

**3** Press **[OK]**. The account is confirmed and printing begins.

---

## Select Account (Department-specific settings)

This specifies the functions used for managing individual account IDs.

The options available in Select Account are as follows:

- Counter (Account-specific counter management [color + Black & White total])
- Color Counter (Account-specific counter management [color])
- Restriction (Print restriction selection [color + Black & White total])
- Color Restrict (Print restriction selection [color])
- Maximum Output (Maximum print output setting [color + Black & White total])
- Color Max. Output (Maximum print output setting [color])
- Reset Counter (Counter reset)

- 1** Press  $\triangleright$  while `Job Accounting >` is displayed.
- 2** Press  $\triangle$  or  $\nabla$  repeatedly until `>Select Account>` appears.
- 3** Press **[OK]**. A blinking question mark (?) appears.

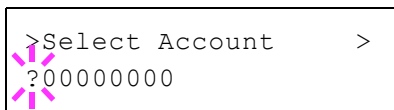

```
>Select Account >
?00000000
```

- 4** Each time you press  $\triangle$  or  $\nabla$ , the next registered account ID in the sequence appears.
- 5** Display the desired account ID and press **[OK]**. Press  $\triangleright$ , the display changes to the individual department setting screen.

## Counter (Account-specific counter management [color + Black & White total])

Displays the total number of pages printed for the currently selected account.

**IMPORTANT** You can only view the counter. You cannot change it.

- 1** Set the account ID and then press  $\triangle$  or  $\nabla$  repeatedly until `>>Counter` appears. (E.g.: 100)  
The counter shows a number between 0000000 and 9999999.

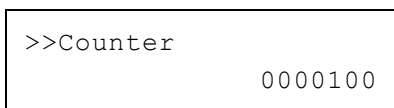

```
>>Counter
0000100
```

- 2** Press **[MENU]**. The display returns to `Ready`.

## Color Counter (Account-specific counter management [color])

Displays the total number of color pages printed for the currently selected account.

**IMPORTANT** You can only view the counter. You cannot change it.

- 1** Set the account ID and then press  $\triangle$  or  $\nabla$  repeatedly until `>>Color Counter` appears. (E.g.: 50)  
The counter shows a number between 0000000 and 9999999.

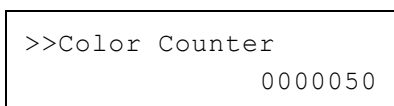

```
>>Color Counter
0000050
```

- 2** Press **[MENU]**. The display returns to `Ready`.

### Restriction (Print restriction selection [color + Black & White total])

Sets restricted functionality for all printing on the currently selected account. You can use the restrictions to prohibit printing by individual departments or to limit the number of pages they can print.

```
>>Restriction
? Off
```

**1** Set the account ID and then press  $\Delta$  or  $\nabla$  repeatedly until `>>Restriction` appears.

**2** Press **[OK]**. A blinking question mark (?) appears.

**3** Press  $\Delta$  or  $\nabla$  repeatedly to select the desired restriction. The displayed restrictions are as follows:

- Off (no restrictions)
- Counter Limit (to limit the number of pages)
- Reject Usage (to prohibit printing)

**4** Press **[OK]**. The restriction is set.

**5** Press **[MENU]**. The display returns to `Ready`.

### Color Restrict (Print restriction selection [color])

Sets restricted functionality for color printing on the currently selected account. You can use the restrictions to prohibit printing by individual departments or to limit the number of pages they can print.

```
>>Color Restriction
? Off
```

**1** Set the account ID and then press  $\Delta$  or  $\nabla$  repeatedly until `>>Color Restriction` appears.

**2** Press **[OK]**. A blinking question mark (?) appears.

**3** Press  $\Delta$  or  $\nabla$  repeatedly to select the desired restriction. The displayed restrictions are as follows:

- Off (no restrictions)
- Counter Limit (to limit the number of pages)
- Reject Usage (to prohibit printing)

**4** Press **[OK]**. The restriction is set.

**5** Press **[MENU]**. The display returns to `Ready`.

### Maximum Output (Maximum print output setting [color + Black & White total])

Limits the number of pages for all printing on the currently selected account.

```
>>Maximum Output
0000001
```

**1** Set the account ID and then press  $\Delta$  or  $\nabla$  repeatedly until `>>Maximum Output` appears.

**2** Press **[OK]**. The message display shows a blinking cursor (  ).

- 3 Press  $\Delta$  or  $\nabla$  to increase or decrease, respectively, the value at the blinking cursor. Set the desired number of pages. You can set a number between 0000001 and 9999999 as the number of pages. Use  $\triangleleft$  and  $\triangleright$  to move the cursor right and left.
- 4 Press [OK].
- 5 Press [MENU]. The display returns to Ready.

### Color Max. Output (Maximum print output setting [color])

Limits the number of pages for color printing on the currently selected account.

- 1 Set the account ID and then press  $\Delta$  or  $\nabla$  repeatedly until `>>Color Max. Output` appears.
- 2 Press [OK]. The message display shows a blinking cursor (|).

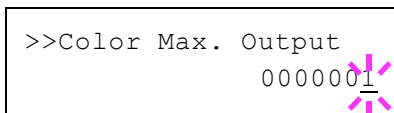

```
>>Color Max. Output
0000001|
```

- 3 Press  $\Delta$  or  $\nabla$  to increase or decrease, respectively, the value at the blinking cursor. Set the desired number of pages. You can set a number between 0000001 and 9999999 as the number of pages. Use  $\triangleleft$  and  $\triangleright$  to move the cursor right and left.
- 4 Press [OK].
- 5 Press [MENU]. The display returns to Ready.

### Reset Counter (Counter reset)

Resets the counter (pages used) for the currently selected account.

- 1 Set the account ID and then press  $\Delta$  or  $\nabla$  repeatedly until `>>Reset Counter` appears.
- 2 Press [OK]. A blinking question mark (?) appears.

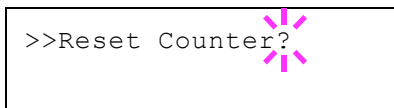

```
>>Reset Counter?
```

- 3 Press [OK] again. The counter is reset.
- 4 Press [MENU]. The display returns to Ready.

### Add Account (Department registration)

This allows you to add a new account for which printing is permitted.

**IMPORTANT** Because account IDs are managed as numeric strings, "1" and "001" are handled as different accounts. Also, once Job Accounting is enabled, no jobs are printed unless information is attached showing the accounts from which the jobs are being printed.

- 1 Press  $\triangleright$  while `Job Accounting >` is displayed.
- 2 Press  $\Delta$  or  $\nabla$  repeatedly until `>Add Account` appears.
- 3 Press [OK]. The message display shows a blinking cursor (|).

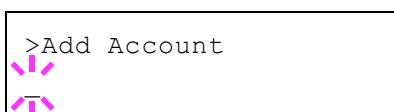

```
>Add Account
|
```

- 4 Press  $\Delta$  or  $\nabla$  to increase or decrease, respectively, the value at the blinking cursor. Set the desired account ID. You can set a number between 1 and 8 digits. Use  $\leftarrow$  and  $\rightarrow$  to move the cursor right and left.



**Note** If you enter an existing account ID, *Wrong Account* is displayed and the input screen reappears. Re-enter the new account ID.

- 5 Press **[OK]**. Account registration ends.
- 6 Press **[MENU]**. The display returns to *Ready*.

### Delete Account (Department removal)

You can use this to delete a registered account.

**IMPORTANT** Because account IDs are managed as numeric strings, "1" and "001" are handled as different accounts. Also, once Job Accounting is enabled, no jobs are printed unless information is attached showing the accounts from which the jobs are being printed.

- 1 Press  $\rightarrow$  while *Job Accounting >* is displayed.
- 2 Press  $\Delta$  or  $\nabla$  repeatedly until *>Delete Account* appears.
- 3 Press **[OK]**. A blinking question mark (?) appears. (E.g.: 001)

```
>Delete Account
?001
```

- 4 Each time you press  $\Delta$  or  $\nabla$ , the next registered account ID in the sequence appears.
- 5 Display the desired account ID and press **[OK]**. The account ID is deleted.
- 6 Press **[MENU]**. The display returns to *Ready*.

### Print Job Accounting List (Job Accounting list output)

This enables you to print the total number of pages for all accounts as a Job Accounting list.

- 1 Press  $\rightarrow$  while *Job Accounting >* is displayed.
- 2 Press  $\Delta$  or  $\nabla$  repeatedly until *>Print Job Accounting List* appears.
- 3 Press **[OK]**. A blinking question mark (?) appears.

```
>Print
Job Accounting List?
```

- 4 When you press **[OK]** again, *Processing* appears and printing begins.
- 5 Press **[MENU]**. The display returns to *Ready*.

### Apply Limit (Operation settings when limits are exceeded)

Use this to specify the action taken when a department exceeds its printing limits.

- 1 Press  $\rightarrow$  while *Job Accounting >* is displayed.
- 2 Press  $\Delta$  or  $\nabla$  repeatedly until *>Apply Limit* appears.

---

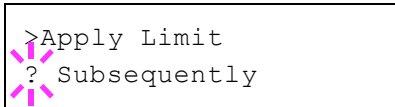

```
>Apply Limit
? Subsequently
```

**3** Press **[OK]**. A blinking question mark (?) appears.

**4** Press  $\Delta$  or  $\nabla$  to select a setting.

Immediately (prohibit printing from this job onwards)

Subsequently (prohibit printing from the next job onwards)

**5** Press **[OK]**.

**6** Press **[MENU]**. The display returns to Ready.

### Unknown ID Job (Operation settings for unknown account IDs)

Use this procedure to specify whether print jobs from departments with unknown account IDs are permitted.

**1** Press  $\triangleright$  while *Job Accounting* > is displayed.

**2** Press  $\Delta$  or  $\nabla$  repeatedly until >Unknown ID Job appears.

**3** Press **[OK]**. A blinking question mark (?) appears.

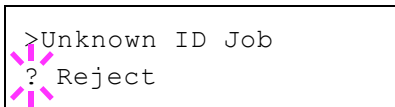

```
>Unknown ID Job
? Reject
```

**4** Press  $\Delta$  or  $\nabla$  to select a setting.

Reject (Not printed)

Permit (Printed)

**5** Press **[OK]**.

**6** Press **[MENU]**. The display returns to Ready.

---

## Administrator (Administrator settings)

The Administrator setting is a function that identifies a user who can use the printer and manage other users.

When using the Security and Job Accounting functions, the administrator ID and password set here are authenticated, and settings can be specified after they are properly authenticated.

The options available in Administrator are as follows:

- ID (Administrator ID input)
- Password (Administrator Password input)
- Change ID (Administrator ID change)
- Change Password (Administrator Password change)

**1** Press **[MENU]**.

**2** Press  $\triangle$  or  $\nabla$  repeatedly until `Administrator >` appears.

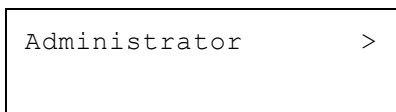

### ID (Administrator ID input)

You can use this to set the administrator ID.



**Note** The default setting is "3000".

**1** Press  $\triangleright$  while `Administrator >` is displayed.

**2** The message display shows `ID` and a blinking cursor (`_`).



**3** Press  $\triangle$  or  $\nabla$  to increase or decrease, respectively, the value at the blinking cursor. Enter the specified ID. Use  $\triangleleft$  and  $\triangleright$  to move the cursor right and left. Enter an ID consisting of between 1 and 16 digits.

**4** Press **[OK]**. Proceed to the next step *Password (Administrator Password input)*.

### Password (Administrator Password input)

You can use this to set the administrator password.



**Note** The default setting is "3000".

**1** Once you have entered the correct ID in the previous step (ID (Administrator ID input)), the message display shows `Password` (Administrator password input) and a blinking cursor (`_`).



**2** Press  $\triangle$  or  $\nabla$  to increase or decrease, respectively, the value at the blinking cursor. Enter the specified password. Use  $\triangleleft$  and  $\triangleright$  to move





---



OK?  
010

- 3** Press  $\triangle$  or  $\nabla$  to increase or decrease, respectively, the value at the blinking cursor. Enter the password to be changed. Use  $\triangleleft$  and  $\triangleright$  to move the cursor right and left. Enter a password consisting of between 0 and 16 numbers.
- 4** Press **[OK]**. A confirmation screen appears. (E.g.: Where the administrator password is changed to 010)
- 5** Press **[OK]**. The new administrator password is confirmed.
- 6** Press **[MENU]**. The display returns to *Ready*.

---

## Adjust/Maintenance (Adjust/Maintenance selection/setting)

Adjust/Maintenance is used to adjust the print quality and to carry out printer maintenance.

The options available in Adjust/Maintenance are as follows:

- Color Calibration
- Registration Normal (Color registration [standard])
- Registration Details (Color registration [detailed])
- Restart Printer
- Service (for maintenance)

**IMPORTANT** *Service* is primarily a menu used by service personnel for maintenance work. There is no need for customers to use this menu.

- 1** Press **[MENU]**.
- 2** Press  $\Delta$  or  $\nabla$  repeatedly until `Adjust/Maintenance >` appears.

`Adjust/Maintenance >`

### Color Calibration

This printer contains a calibration function that automatically makes adjustments to compensate for changes that occur over time due to variations in the ambient temperature and humidity. So that the highest quality color printing can be maintained, this color calibration operation is carried out automatically each time the power to the printer is turned on. The color calibration operation may be carried out automatically during recovery from the Auto Sleep or during printing.

- 1** Press  $\triangleright$  while `Adjust/Maintenance >` is displayed.
- 2** Press  $\Delta$  or  $\nabla$  repeatedly until `>Color Calibration` appears.
- 3** Press **[OK]**. A question mark (?) appears.

`>Color Calibration ?`

- 4** Press **[OK]** again. The message display shows `Please wait (Calibrating)` and calibration will start.
- 5** When calibration is finished, the display returns to `Ready`.

### Registration Normal (Color registration [standard])

When using the printer for the first time after set-up or after having moved it, or if printout of any color (magenta, cyan or yellow) is skewed, use this mode to correct the color registration on the operation panel.

The options available in Registration Normal (Color registration (standard)) are as follows:

- Print Registration Chart (Printing the color registration correction chart)
- Adjust Magenta
- Adjust Cyan
- Adjust Yellow

---

### Print Registration Chart (Printing the color registration correction chart)

You can use this option to print a color registration correction chart for use in correcting the color registration.

- 1** Press  $\triangleright$  while `Adjust/Maintenance >` is displayed.
- 2** Press  $\triangle$  or  $\nabla$  repeatedly until `>Registration Normal >` appears.
- 3** Press  $\triangleright$ .
- 4** Press  $\triangle$  or  $\nabla$  repeatedly until `>>Print Registration Chart` appears.
- 5** Press **[OK]**. A question mark (?) appears.

`>>Print  
Registration Chart ?`

- 6** Press **[OK]**. `Processing` appears and a color registration correction chart is printed out. There are left (L), vertical (V) and right (R) registration charts for each color (magenta, cyan and yellow) included on the color registration correction chart.

## Sample Color Registration Correction Chart

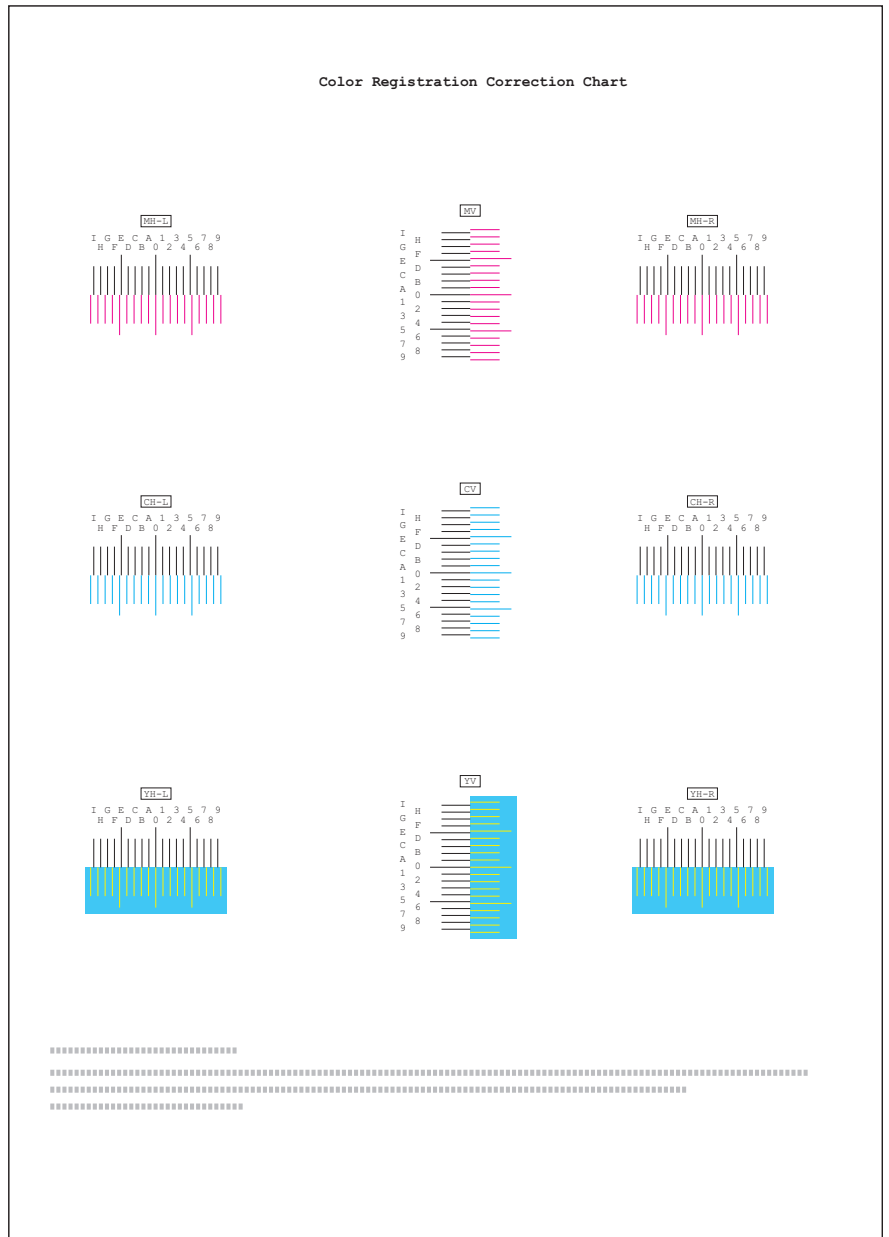

**7** When printing ends, the display returns to Ready.

### Adjust Magenta

Corrects the registration for magenta (red).

- 1** Press  $\triangleright$  while Adjust/Maintenance > is displayed.
- 2** Press  $\triangle$  or  $\nabla$  repeatedly until >Registration Normal > appears.
- 3** Press  $\triangleright$ .
- 4** Press  $\triangle$  or  $\nabla$  repeatedly until >>Adjust Magenta appears.
- 5** Press [OK]. 0 will be displayed for each value and the cursor (  $\_$  ) will flash under the left (L) value.

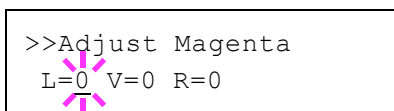

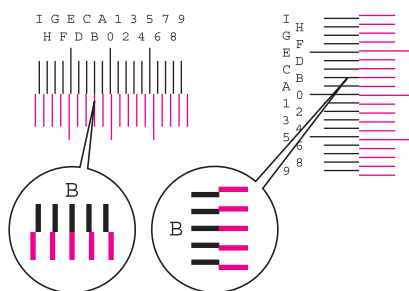

```
>>Adjust Magenta
L=B V=0 R=0
```

**6** Look at the left chart (L) in the magenta portion of the color registration correction chart. Find the two lines that most seem to overlap as a single straight line and note the number value listed there. In the left example, the value would be B.

**7** Press  $\Delta$  or  $\nabla$  until that value is displayed.

**8** Use  $\triangleleft$  and  $\triangleright$  to move the cursor right and left. Perform the same operation as you did for the left (L) value in order to find the vertical (V) and right (R) values for magenta in the color registration correction chart, and select those values on the operation panel as well.

**9** Press **[OK]**. OK? and each of the entered values will be displayed. If the displayed values are correct, press **[OK]**.

Now continue to the settings for cyan and yellow.

### Adjust Cyan (Cyan correction) and Adjust Yellow (Yellow correction)

These options correct the registration for cyan (blue) and yellow.

**10** After completing the settings for magenta in step 9 above, press  $\nabla$ . `>>Adjust Cyan` will be displayed and, once you complete the settings for that color, `>>Adjust Yellow` will be displayed. Perform the same operation as you did for the magenta chart in order to find the values for cyan and yellow in the color registration correction chart, and perform those settings in the same way.

**11** Once you have completed the settings for all 3 colors, press **[MENU]**. The display returns to *Ready*.

This completes the standard color registration correction.



**Note** As confirmation, try printing the color registration correction chart again. If the section where the lines most closely coincide as a single straight line is not 0, redo the settings again from step 4 above.

**IMPORTANT** If the problem of skewed-color printout still persists even after correcting the color registration, call for service.

### Registration Details (Color registration [detailed])

This allows you to make fine horizontal and vertical adjustments to the color registration corrections.

The options available in Registration Details (Color registration (detailed)) are as follows:

- Print Registration Chart (Printing the color registration correction chart)
- M 12345 3 (Adjust magenta)
- C 12345 3 (Adjust cyan)
- Y 12345 3 (Adjust yellow)

---

### Print Registration Chart (Printing the color registration correction chart)

You can use this option to print a color registration correction chart for use in correcting the color registration.

- 1** Press  $\triangleright$  while `Adjust/Maintenance >` is displayed.
- 2** Press  $\triangle$  or  $\nabla$  repeatedly until `>Registration Details >` appears.
- 3** Press  $\triangleright$ .
- 4** Press  $\triangle$  or  $\nabla$  repeatedly until `>>Print Registration Chart` appears.
- 5** Press **[OK]**. A question mark (?) appears.

`>>Print  
Registration Chart ?`

- 6** Press **[OK]**. Processing appears and a color registration correction chart is printed out. There are horizontal (H) and vertical (V) registration charts for each color (magenta, cyan and yellow) included on the color registration correction chart.

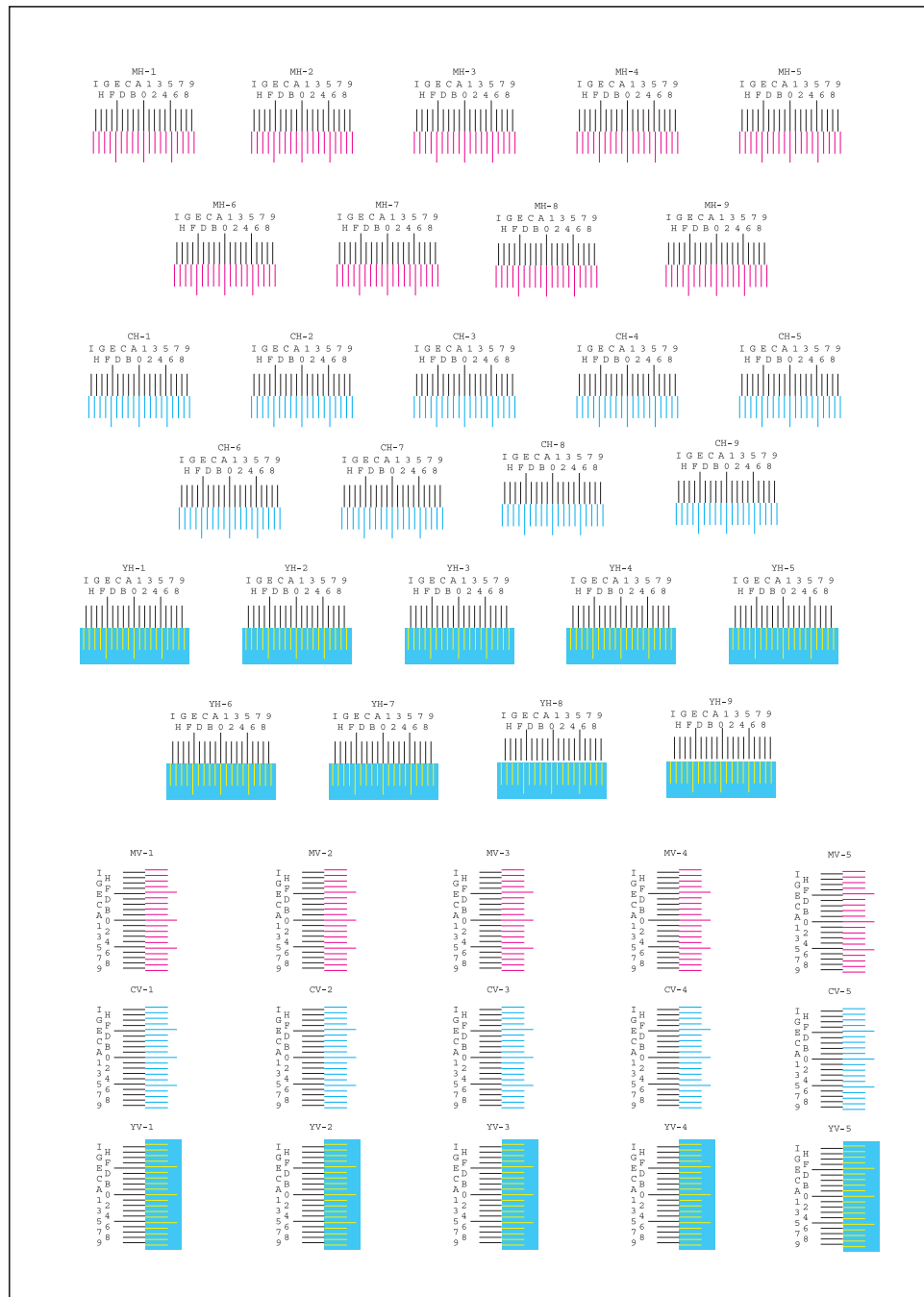

- 7** When printing ends, the display returns to Ready.

### M 12345 3 (Adjust magenta)

Makes detailed corrections to the registration for magenta (red).

- 1** Press **▷** while Adjust/Maintenance > is displayed.
- 2** Press **△** or **▽** repeatedly until >Registration Details > appears.
- 3** Press **▷**.

```
>>M 12345 3
MH=00000 MV=0
```

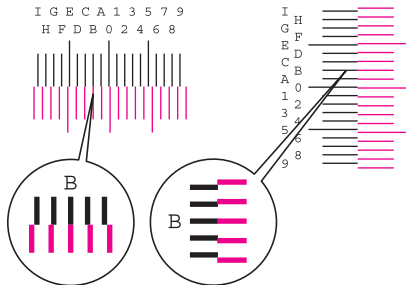

```
>>M 12345 3
MH=B0000 MV=0
```

```
>>M 1 2 3 4 5 3
MH = 0 0 0 0 0 MV = 0
```

MH-1  
MH-2  
MH-3  
MH-4  
MH-5

MV-3

- 4 Press  $\Delta$  or  $\nabla$  repeatedly until `>>M 12345 3` appears.
- 5 Press **[OK]**. `00000` or `0` will be displayed for each value and the cursor (`_`) will flash under the H value.
- 6 In the color registration correction chart printed in Print Registration Chart above, note the numbers of the sections in the magenta H and V charts where the lines most closely coincide as a single straight line. In the left example, the value would be B.
- 7 Press  $\Delta$  or  $\nabla$  until that value is displayed.
- 8 Use  $\triangleleft$  and  $\triangleright$  to move the cursor right and left. Perform the same operation as you did for the H value in order to find the V values in the color registration correction chart, and select those values on the operation panel as well.
- 9 Press **[OK]**. `OK?` and each of the entered values will be displayed. If the numbers shown are correct, press **[OK]**. This completes the settings for magenta.

Now continue to the settings for cyan and yellow.

### C 12345 3 (Adjust Cyan) and Y 12345 3 (Adjust Yellow)

These options make detailed corrections to the registration for cyan (blue) and yellow.

- 10 After completing the settings for magenta in step 9 above, press the  $\nabla$  key. `>>C 12345 3` and `>>Y 12345 3` are displayed. As with magenta, note down the values for cyan and yellow from the color registration correction chart.
- 11 After completing the settings for all three colors, press **[MENU]**. The display returns to *Ready*.

This completes the detailed color registration correction.



**Note** As confirmation, try printing the color registration correction chart again. If the section where the lines most closely coincide as a single straight line is not 0, redo the settings again from step 4 above.

**IMPORTANT** If the problem of skewed-color printout still persists even after correcting the color registration, call for service.



---

## Restart Printer

The procedure described below resets the printer's temporary conditions, such as the current page orientation, font, etc., set by commands to their default values. Downloaded fonts and macros are deleted from the printer's memory.

>Restart Printer ?

- 1** Press  $\triangleright$  while `Adjust/Maintenance >` is displayed.
- 2** Press  $\triangle$  or  $\nabla$  repeatedly until `>Restart Printer` appears.
- 3** Press **[OK]**. A question mark (?) appears.

- 4** Press **[OK]** again. `Self test` appears while the printer is resetting itself, followed by `Please wait` and then `Ready`.

## Service (for maintenance)

The options available in Service are as follows:

- Print Status Page (Printing the service status page)
- Print Network Status Page (Printing the network status page)
- Print Op Network Status Page (Printing the option network status page)
- Print Test Page
- Write Data
- Maintenance (New Maintenance Kit replacement confirmation setting)
- DEV-CLN (Developer/Refresh mode setting)
- LSU (LSU cleaning mode setting)
- Drum (Drum/Refresh mode setting)

**IMPORTANT** `Service` is primarily a menu used by service personnel for maintenance work. There is no need for customers to use this menu.

>Service >

- 1** Press  $\triangleright$  while `Adjust/Maintenance >` is displayed.
- 2** Press  $\triangle$  or  $\nabla$  repeatedly until `>Service >` appears.

## Print Status Page (Printing the service status page)

The service status page contains printer settings information that is more detailed than the standard status page and is therefore mostly for service purposes. However, there is a great deal of information on the service status page that may be useful to you.

>>Print Status Page ?

- 1** Press  $\triangleright$  while `>Service >` is displayed.
- 2** Press  $\triangle$  or  $\nabla$  repeatedly until `>>Print Status Page` appears.
- 3** Press **[OK]**. A question mark (?) appears.

- 4** Press **[OK]** again. `Processing` appears and a service status page is printed out.

- 
- 5 When printing ends, the display returns to *Ready*.

#### Print Network Status Page (Printing the network status page)

The network status page contains detailed information on the network settings. This is primarily used for maintenance by service personnel, but it contains information that may also be useful to you.

- 1 Press  $\triangleright$  while *>Service >* is displayed.
- 2 Press  $\triangle$  or  $\nabla$  repeatedly until *>>Print Network Status Page* appears.
- 3 Press **[OK]**. A question mark (?) appears.

```
>>Print
Network Status Page?
```

- 4 Press **[OK]** again. *Processing* appears and a network status page is printed out.
- 5 When printing ends, the display returns to *Ready*.

#### Print Op Network Status Page (Printing the option network status page)

The option network status page contains detailed information on the network settings. This is primarily used for maintenance by service personnel, but it contains information that may also be useful to you.

- 1 Press  $\triangleright$  while *>Service >* is displayed.
- 2 Press  $\triangle$  or  $\nabla$  repeatedly until *>>Print Op Network Status Page* appears.
- 3 Press **[OK]**. A question mark (?) appears.

```
>>Print Op
Network Status Page?
```

- 4 Press **[OK]** again. *Processing* appears and an option network status page is printed out.
- 5 When printing ends, the display returns to *Ready*.

#### Print Test Page

The test page is printed to check the effectiveness of printer adjustments. This is primarily used for maintenance by service personnel, but it contains information that may also be useful to you.

- 1 Press  $\triangleright$  while *>Service >* is displayed.
- 2 Press  $\triangle$  or  $\nabla$  repeatedly until *>>Print Test Page* appears.
- 3 Press **[OK]**. A question mark (?) appears.

```
>>Print Test Page ?
```

- 4 Press **[OK]** again. *Processing* appears and a test page is printed out.
- 5 When printing ends, the display returns to *Ready*.

---

## Write Data

This writes data to USB memory.



**Note** This menu only appears when USB memory is inserted.

>>Write Data ?

- 1 Press  $\triangleright$  while `>Service >` is displayed.
- 2 Press  $\triangle$  or  $\nabla$  repeatedly until `>>Write Data` appears.
- 3 Press **[OK]**. A question mark (?) appears.
- 4 Press **[OK]** again. `Data waiting` is displayed and the device enters the standby state.
- 5 When data is received from the PC, `Processing` is displayed and the data is written to the USB memory.
- 6 When writing ends, the display returns to `Ready`.

## Maintenance (New Maintenance Kit replacement confirmation setting)

This specifies the setting for confirmation of replacement with the new Maintenance Kit (resets the total number of Maintenance Kit print images). This is primarily used for maintenance by service personnel.



**Note** The `Maintenance` menu is displayed only when `Replace MK` appears.

>>Maintenance ?

- 1 Press  $\triangleright$  while `>Service >` is displayed.
- 2 Press  $\triangle$  or  $\nabla$  repeatedly until `>>Maintenance` appears.
- 3 Press **[OK]**. A question mark (?) appears.
- 4 Press **[OK]** again. The confirmation of replacement with the new Maintenance Kit is set.
- 5 When the replacement ends, the display returns to `Ready`.

## DEV-CLN (Developer/Refresh mode setting)

This sets the refresh mode for the developer. When the printing quality declines, refreshing the developer can restore the printing quality. This is primarily used for maintenance by service personnel.

>>DEV-CLN ?

- 1 Press  $\triangleright$  while `>Service >` is displayed.
- 2 Press  $\triangle$  or  $\nabla$  repeatedly until `>>DEV-CLN` appears.
- 3 Press **[OK]**. A question mark (?) appears.
- 4 Press **[OK]** again. Developer refreshing begins and `Please wait` is displayed.

- 
- 5 When refreshing ends, the display returns to *Ready*.

#### LSU (LSU cleaning mode setting)

This sets the cleaning mode for the LSU. When the printing quality declines, cleaning the LSU can restore the printing quality. This is primarily used for maintenance by service personnel.

- 1 Press  $\triangleright$  while *>Service >* is displayed.
- 2 Press  $\triangle$  or  $\nabla$  repeatedly until *>>LSU* appears.
- 3 Press **[OK]**. A question mark (?) appears.



>>LSU ?

- 4 Press **[OK]** again. LSU cleaning mode begins and *Please wait (Cleaning)* is displayed.
- 5 When cleaning ends, the display returns to *Ready*.

#### Drum (Drum/Refresh mode setting)

This sets the refresh mode for the drum. When the printing quality declines, refreshing the drum can restore the printing quality. This is primarily used for maintenance by service personnel.

- 1 Press  $\triangleright$  while *>Service >* is displayed.
- 2 Press  $\triangle$  or  $\nabla$  repeatedly until *>>Drum* appears.
- 3 Press **[OK]**. A question mark (?) appears.

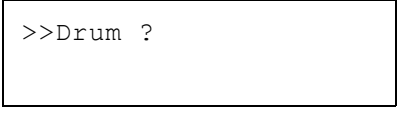

>>Drum ?

- 4 Press **[OK]** again. Drum refreshing begins and *Please wait* is displayed.
- 5 When refreshing ends, the display returns to *Ready*.



# 3 Options

---

This chapter contains explanations on the following topics:

<b>General Information</b>	<b>3-2</b>
<b>Expansion Memory Modules</b>	<b>3-3</b>
<b>General Description of Options</b>	<b>3-5</b>

For availability of the options, consult your service technician.

## General Information

This printer has the following options available to satisfy your printing requirements. For instructions on installing individual options, refer to the documentation included with the option. Some options are explained in the following sections.

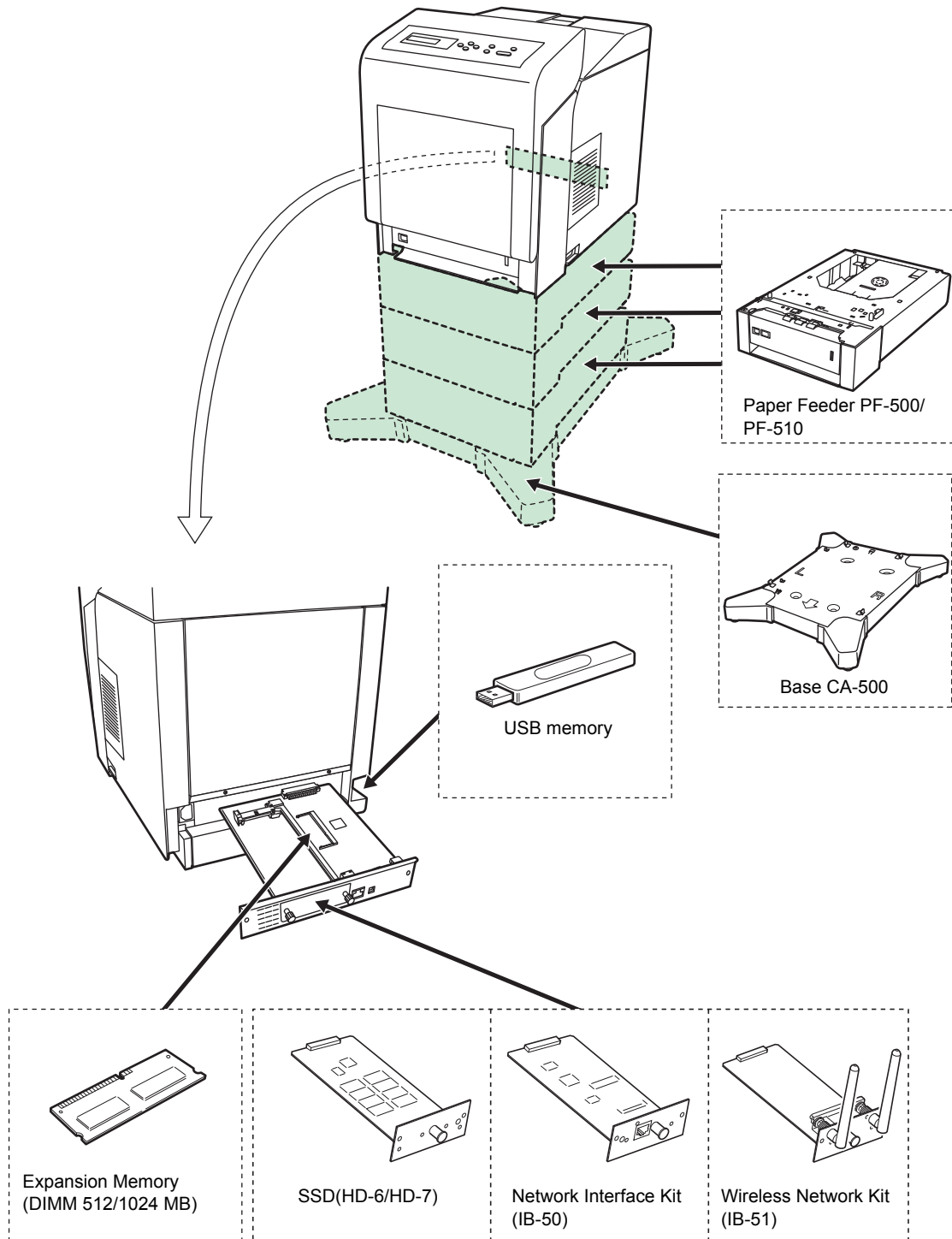

---

## Expansion Memory Modules

The printer's main controller board has a memory slot into which you can plug in optional memory modules (dual in line memory modules). You can increase the printer's memory up to 1536 MB by plugging in the optional memory modules.

 **Note** A 512 MB memory module is already installed at the factory. To expand memory up to 1536 MB, install 1024 MB memory module.

### Expansion Memory Modules

You can select additional memory modules from 512 or 1024 MB. The maximum memory size is 1024 MB.

### Precautions for Handling the Printer's Main Controller Board and Memory Modules

To protect electronic parts, discharge static electricity from your body by touching a water pipe (faucet) or other large metal object before handling the memory modules. Or, wear an antistatic wrist strap, if possible, when you install the memory modules.

Always hold the main controller board or a memory module by its edges as shown below to avoid damaging electronic parts.

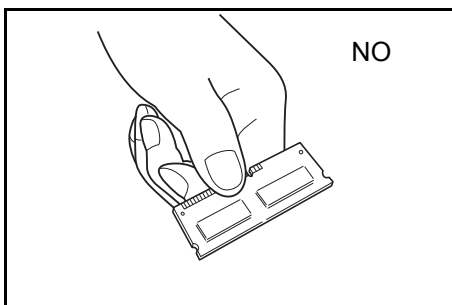
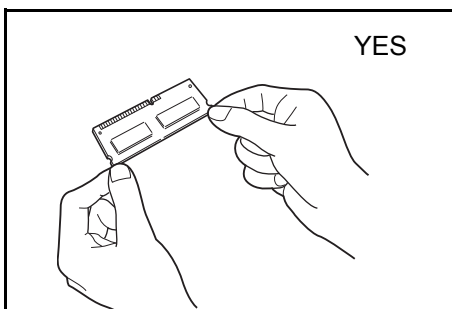



---

## Installing the Memory Modules

**IMPORTANT** Remove any USB memory that is attached to the printer's USB memory slot.

- 1 Power off the printer and unplug the printer power cord.
- 2 Unscrew two screws at the back of the main controller board.

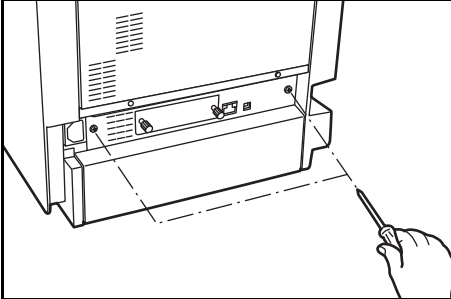

- 3 Pull out the main controller board gently.

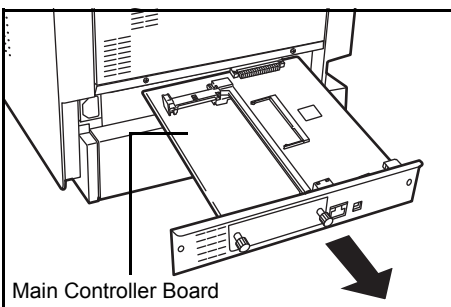

- 4 Remove the memory module from its package. Aligning the cutouts of the memory module with the matching keys of the socket, carefully plug the memory module into the memory socket until it clicks in place.



**CAUTION** Do not plug the memory module backwards.

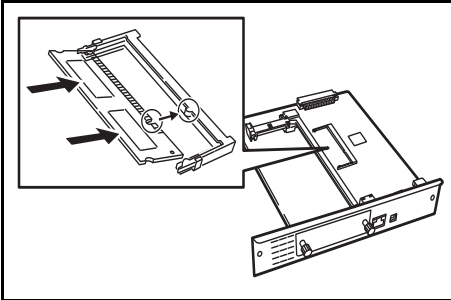

- 5 Push down the memory module to secure.

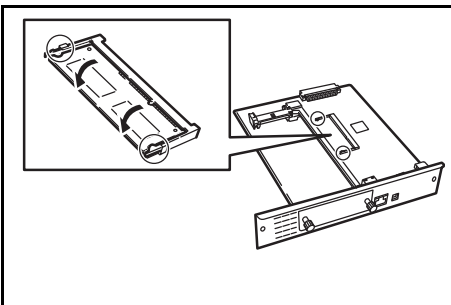

- 6 After you finish installing the memory modules, reinstall the main controller board and fasten it with screws.

## Removing a Memory Module

To remove a memory module, remove the main controller board, then carefully push out the two socket clamps. Ease the memory module out of the socket to remove.

---

## General Description of Options

### PF-500, PF-510 Paper Feeder

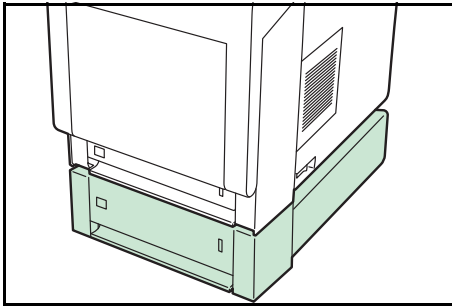

The optional paper feeder PF-500 (for plain paper) and PF-510 (for multiuse media) will each hold approximately 500 sheets of paper. Up to 3 optional feeders can be added to the bottom of the printer, allowing continuous feeding of up to 2,000 sheets of paper when combined with the printer's own cassette.

**IMPORTANT** When you use the paper feeder, place the papers and envelopes print-side up.

The papers that can be used in the cassettes supplied with the paper feeders are as follows:

#### PF-500 :

Paper size : Envelope Monarch, Envelope #10, Envelope #9, Envelope #6, Envelope DL, Envelope C5, A5, B5, ISO B5, A4, Executive, Letter, Legal, OufukuHagaki, Oficio II, Statement, Folio, Youkei 2, Youkei 4, 16K and Other (92 x 165 mm to 216 x 356 mm)

Paper type : Plain, preprinted, bond, recycled, rough, letterhead, color, prepunched, high quality, custom 1 (to 8)

#### PF-510 :

Paper size : Envelope Monarch, Envelope #10, Envelope #9, Envelope #6, Envelope DL, Envelope C5, A5, B5, ISO B5, A4, Executive, Letter, Legal, OufukuHagaki, Oficio II, Statement, Folio, Youkei 2, Youkei 4, 16K and Other (92 x 162 mm to 216 x 356 mm)

Paper type : Plain, preprinted, labels, bond, recycled, rough, letterhead, color, prepunched, cardstock, envelope, coated, thick, high quality, custom 1 (to 8)

**IMPORTANT** Please make sure that the machine is stable, by placing the paper feeders on a sturdy desk or base.

### Base (CA-500)

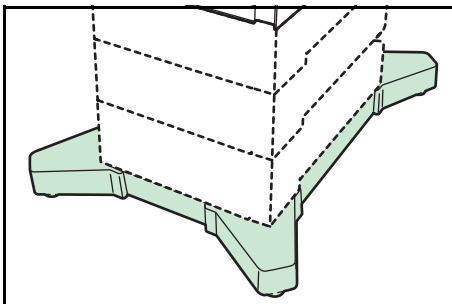

If you are attaching paper feeder PF-500 or PF-510 to the printer and installing it on the floor, you can use a base to maintain the machine's stability.

For detailed information on installing the base, refer to the manual supplied with the base.

**IMPORTANT** Be careful to not trip on the feet of the base.

## SSD

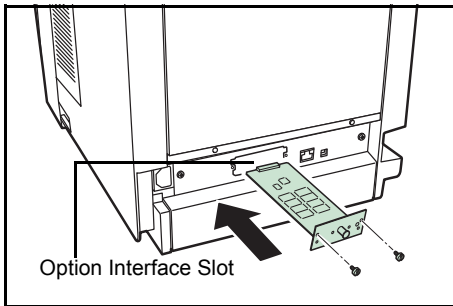

With SSD installed in the printer, received data can be rasterized and stored on this SSD. This enables high-speed printing of multiple copies using an electric sort function. Also, you can use the Custom Box and Job Box functions. For details, refer to *Custom Box (Using a Custom Box)* on page 2-18 and *Job Box* on page 2-22.

## Network Interface Kit (IB-50)

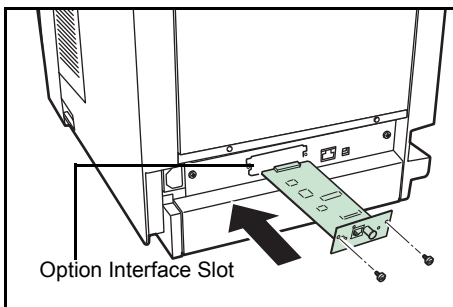

The network interface kit is a high-speed interface for communications speeds of 1 gigabit per second. In addition to the TCP/IP and NetBEUI supported by the machine's standard network interface, it also supports IPX/SPX and Apple Talk, so network printing becomes possible in various environments, including Windows, Macintosh, UNIX and Netware. For details, refer to *IB-50 User's Manual*.

## Wireless Network Interface Kit (IB-51)

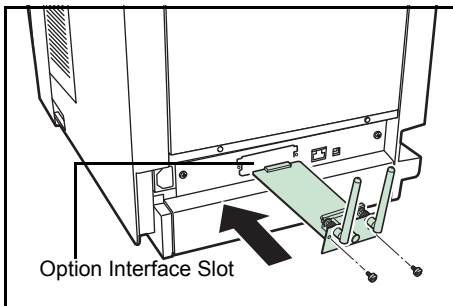

This is a wireless network interface kit which supports the wireless network specifications IEEE802.11n (Max 300 Mbps) and 11 g/b.

With the utilities supplied, settings are possible for a variety of OS and network protocols. For details, refer to *IB-51 User's Manual*.

## USB Memory

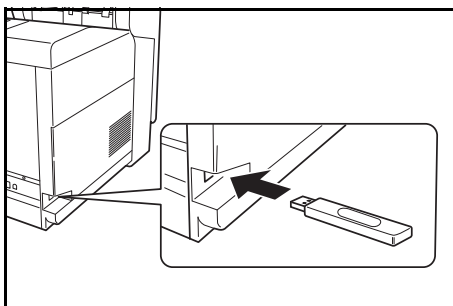

USB memory is a type of simple, highly portable flash memory that plugs into the USB memory slot. Files stored in USB memory can be printed by plugging the USB memory into the printer and then specifying the desired file names from the operation panel.

The operation panel displays the names of PDF, TIFF, JPEG and XPS files.

Up to 100 files can be printed from USB memory. Files with names consisting of up to 99 single-byte alphanumeric characters can be printed. However, because the message display will only show 12 characters, files with 13 or more characters cannot be identified on the message display.

Any double-byte characters included in a file name appear as corrupted text in the message list. Also, when the file is printed an error message appears and printing fails.

For information on printing PDF files stored in USB memory, refer to *USB Memory (USB memory selection)* on page 2-16.

For information on supported USB memory devices, contact your service technician.

# 4 Computer Interface

---

This chapter contains explanations on the following topics:

<b>Interface</b>	<b>4-2</b>
<b>USB Interface</b>	<b>4-2</b>
<b>Network Interface</b>	<b>4-3</b>

---

## Interface

This chapter explains the signals used in the printer's USB, and network interfaces. It also lists pin assignments, signal functions, timings, connector specifications, and voltage levels.

- USB Interface
- Network Interface

## USB Interface

This printer supports the Hi-Speed USB. USB (Universal Serial Bus) interface specifications and interface signals are as follows.

### Specifications

#### Basic Specification

Complies with the Universal Serial Bus Specification Revision 2.0.

#### Connectors

Printer: B-type receptacle (female) with upstream port

Cable: B-type plug (male)

#### Cable

Use a shielded cable that complies with USB 2.0 (Hi-Speed USB) and not longer than 5 meters (16 feet).

#### Transfer Mode

High speed (480 Mbps maximum)

Full-Speed (12 Mbps maximum)

#### Power Control

Self-power device

## Interface Signals

### USB Connector Pin Assignment

Pin	Signal	Description
1	Vbus	Power supply (+5 V)
2	D-	Data transmission
3	D+	Data transmission
4	GND	Signal ground
Shell	—	Shield

---

## Network Interface

### Features

#### Automatic IP Address Resolution

This feature is compatible with the DHCP/DHCPv6 protocol and allows the printer to automatically receive IP addresses from the DHCP/DHCPv6 server.

#### Management using Web Browsers

HTTP pages are incorporated in to the interface, so that a web browser can be used to monitor and change a range of settings. The settings can be password-protected.

#### Support for a Range of Protocols

The SMTP, POP3, SSL, SNMP, IPv6 and NetBIOS over TCP/IP protocols are supported for easier printer management and more robust security.

#### Support for IEEE 802.1X

The interface supports EAP-TLS and PEAP authentication.

#### Supports IPv6

Supports IPv6, which is based on IPv4 with improvements, such as increased manageable address space, additional security functions and priority based data transmission.

#### Supports IPSec

Supports IPSec, the security protocol that authenticates and encrypts in the network layer (IP layer).

### Specifications

#### Connector

10 Base-T/100 Base-TX/1000 BASE-T

#### Operating Systems

Windows XP/Vista/7/8/Server2003/2008/2012 R2, MacOS 10.5 or later

#### Network Protocols

- IPv6: HTTP, HTTPS, LPD, FTP, IPP, RawPort, ICMPv6, LLTD, SNMP, DHCPv6, SMTP, POP3, DNS, SNMPv1/v2c/v3, IPPS, WSD
- IPv4: HTTP, HTTPS, LPD, FTP, IPP, RawPort, ICMP, DHCP, SMTP, POP3, SNMP, DNS, WINS, NetBIOS over TCP/IP, SNMPv1/v2c/v3, Bonjour, IPPS, LLTD, WSD
- Etc.: IPX/SPX, NetWare (NDS/Bindery), NetBEUI

#### Security Protocols

SSL/TLS (HTTPS, IPPS), SNMPv3, EAP-TLS, PEAP, AH, ESP

---

### **Operation Environment**

10 to 35 °C (50 to 95 °F), 20-80 % RH (condensation-free)

### **EMI Countermeasures**

VCCI Class B, FCC Class B (U.S.), CE (Europe)

**IMPORTANT** When IPv6 functions are used, the devices used on the network (routers, PCs, etc) must support IPv6.

# Glossary

---

## **Additional memory**

An additional memory (optional) is used for increasing the memory capacity of this machine. For DIMM that can be used in this machine, contact your service technician.

## **AppleTalk**

AppleTalk offers file sharing and printer sharing and it also enables you to utilize application software that is on another computer on the same AppleTalk network.

## **Auto-IP**

Auto-IP is a module that enables dynamic IPv4 addresses to be assigned to a device on startup. However, DHCP requires a DHCP server. Auto-IP is a server-less method of choosing an IP address. IP addresses between 169.254.0.0 to 169.254.255.255 are reserved for Auto-IP and assigned automatically.

## **Bonjour**

Bonjour, also known as zero-configuration networking, is a service that automatically detects computers, devices and services on an IP network. Bonjour, because an industry-standard IP protocol is used, allows devices to automatically recognize each other without an IP address being specified or DNS server being set. Bonjour also sends and receives network packets by UDP port 5353. If a firewall is enabled, the user must check that UDP port 5353 is left open so that Bonjour will run correctly. Some firewalls are set up so as to reject only certain Bonjour packets. If Bonjour does not run stably, check the firewall settings and ensure that Bonjour is registered on the exceptions list and that Bonjour packets are accepted. If you install Bonjour on Windows XP Service Pack 2 or later, the Windows firewall will be set up correctly for Bonjour.

## **Custom Box**

The Custom Box function stores print data for each individual user on the printer and allows the user to print single or multiple copies of the stored data later using the printer's operation panel.

## **Default Gateway**

This indicates the device, such as a computer or router, that serves as the entrance/exit (gateway) for accessing computers outside of the network that you are on. When no specific gateway is designated for a destination IP address, data is sent to the host that is designated as the Default Gateway.

## **DHCP (Dynamic Host Configuration Protocol)**

This is a protocol that automatically resolves the IP address, Subnet Mask and Gateway address on a TCP/IP network. Use of DHCP minimizes the load of network administration, especially on network environments with a large number of client computers where it is not specifically necessary to assign a separate IP address to each client, including printers.



---

### **dpi (dots per inch)**

This indicates the number of dots printed per inch (25.4 mm) as a unit for expressing resolution.

### **EcoPrint**

This is a printing mode that reduces toner consumption. Pages printed in the EcoPrint mode are lighter than pages printed in the normal mode.

### **Emulation**

This refers to emulation of other manufacturers' printers. The printer emulates operation of the following printers: PCL6 and KPDL.

### **Form Feed Timeout**

While data is being sent to a printer, some pauses may occur. At this time, the printer waits for the next data without making a page break. Form feed timeout is a function to wait only a preset amount of time before it executes an automatic page break. After the waiting period begins, once the designated amount of time is exceeded, the printer will automatically process the currently received data and print it out. If the machine has received no print data for the last page, the printer ends processing of that job without outputting paper.

### **IP Address (Internet Protocol Address)**

The Internet Protocol address is a unique number that represents a specific computer in a network. The format of an IP Address is four numbers separated by dots, e.g. 192.168.110.171. Each number should be a decimal between 0 and 255.

### **Job Box**

The Job Box function stores print data on the printer and allows users to print single or multiple copies of the stored data later using the printer's operation panel.

### **KPDL**

KPDL is Kyocera's implementation of the PostScript page description language Level3.

### **MP Tray**

This tray is used instead of the cassette when printing on envelopes, postcards, transparency sheets, and labels.

### **NetBEUI (NetBIOS Extended User Interface)**

An enhanced version of the NetBIOS protocol, it enables the utilization of more advanced functions on small-scale networks than do other protocols such as TCP/IP, etc.

### **NetWare**

Novell's network management software that is able to run on a variety of operating systems.

---

## **Outline font**

With outline fonts, character outlines are represented with numerical expressions and fonts can be enlarged or reduced in different ways by changing the numeric values of those expressions. Printing remains clear even if you enlarge fonts, since the characters are defined with outlines represented with numerical expressions. You can specify the font size in steps of 0.25 points up to 999.75 points.

## **POP3 (Post Office Protocol 3)**

A standard protocol to receive E-mail from the server in which the mail is stored on the Internet or an intranet.

## **PostScript**

This is a page description language developed by Adobe Systems, Inc. It enables flexible font functions and highly-functional graphics, allowing higher quality printing.

## **PPM (prints per minute)**

This indicates the number of printouts made in one minute.

## **Printer driver**

The printer driver makes it possible for you to print data created using application software. The printer driver for the printer is contained on the DVD-ROM supplied with the printer. Install the printer driver on the computer connected to the printer.

## **RA (Stateless)**

The IPv6 router communicates (transmits) information such as the global address prefix using ICMPv6. This information is the Router Advertisement (RA). ICMPv6 stands for Internet Control Message Protocol, and is an IPv6 standard defined in the RFC 2463 "Internet Control Message Protocol (ICMPv6) for the Internet Protocol Version 6 (IPv6) Specification".

## **Sleep mode**

This mode is provided to save power. It is activated when the machine is not used for a preset period of time. In this mode, power is reduced to the minimum. The default setting can be changed.

## **SSD (Solid State Drive)**

An SSD is a media for data storage using flash memory.

Whereas HDD generally use magnetic discs as the storage media, SSD are a storage media which use semiconductors.

Compared with HDD, on which a head reads from the magnetic disk, the merits of SSD are that they can read data at higher speeds, they are resistant to vibrations, and they do not require motors, which mean that they consume less electricity and there is no drive noise.

---

### **Status page**

This lists machine conditions, such as the machine's memory, the total number of prints and paper source settings. You can print the status page from the operation panel.

### **Subnet Mask**

This is a 32-bit numerical value that defines which bits of the IP address specify the network address and which specify the host address.

### **TCP/IP (Transmission Control Protocol/Internet Protocol)**

TCP/IP is a suite of protocols designed to define the way computers and other devices communicate with each other over a network.

### **TCP/IP (IPv6)**

TCP/IP (IPv6) is based on the current Internet protocol, TCP/IP (IPv4). IPv6 is the next-generation Internet protocol and expands the available address space, which resolves the problem of the lack of addresses under IPv4, while also introducing other improvements such as additional security functionality and the capacity to prioritize data transmission.

### **USB (Universal Serial Bus) 2.0**

A USB interface standard for Hi-Speed USB 2.0. The maximum transfer rate is 480 Mbps. This machine is equipped with USB 2.0 for high-speed data transfer.

# Index

---

## A

Additional memory . . . . . Glossary-1  
Administrator ID 2-56, 2-62, 2-69, 2-73, 2-75, 2-77, 2-79,  
2-87, 2-94  
    Change . . . . . 2-95  
Administrator Password 2-56, 2-62, 2-70, 2-74, 2-75, 2-77,  
2-79, 2-88, 2-94  
    Change . . . . . 2-95  
Alarm (Buzzer) . . . . . 2-64  
AppleTalk . . . . . Glossary-1  
Auto Cassette Change . . . . . 2-38  
Auto-IP . . . . . 2-48, Glossary-1  
Automatic Cassette Selection . . . . . 2-38

## B

Bonjour . . . . . 2-50, Glossary-1

## C

Canceling a Printing Job . . . . . 2-6  
Cassette  
    Paper size . . . . . 2-31  
    Paper type . . . . . 2-33  
Color Calibration . . . . . 2-97  
Color Mode  
    Color or Black & White . . . . . 2-42  
Color Registration  
    Detailed . . . . . 2-100  
    Standard . . . . . 2-97  
Conventions . . . . . vi  
Counter . . . . . 2-28  
Custom Box . . . . . 2-18  
    Custom box list . . . . . 2-21  
    Manipulating data . . . . . 2-19  
    Select box . . . . . 2-18

## D

Date Setting . . . . . 2-62  
Default Gateway . . . . . Glossary-1  
DHCP . . . . . 2-48, Glossary-1  
dpi . . . . . Glossary-2  
Duplex Printing . . . . . 2-39  
    Binding modes . . . . . 2-40  
    Error detection . . . . . 2-68

## E

EcoPrint . . . . . Glossary-2  
Emulation . . . . . Glossary-2  
    on the status page . . . . . 2-14  
    Setting . . . . . 2-41  
Enhanced WSD . . . . . 2-81  
Enhanced WSD (SSL) . . . . . 2-82  
Error Detection  
    Duplex printing . . . . . 2-68

MP tray empty . . . . . 2-69  
Paper mismatch . . . . . 2-68  
Setting . . . . . 2-68

## F

Form Feed Timeout . . . . . Glossary-2

## G

Gateway . . . . . 2-50

## I

Interface Block . . . . . 2-80  
IP Address . . . . . 2-49, Glossary-2  
IPP (Internet Printing Protocol) . . . . . 2-82  
IPSec (IP Security Protocol) . . . . . 2-85

## J

Job Accounting . . . . . 2-88  
Job Box . . . . . 2-22  
    Configuration . . . . . 2-26  
    Private print job . . . . . 2-25  
    Proof-and-Hold . . . . . 2-24  
    Quick copy . . . . . 2-23  
Job Name Setting . . . . . 2-46  
Job Retention . . . . . 2-22

## K

Keys  
    Arrow keys . . . . . 2-6  
    Basic operation . . . . . 2-6  
    Cancel . . . . . 2-6  
    GO . . . . . 2-6  
    MENU . . . . . 2-6  
    OK . . . . . 2-7  
KPDL . . . . . Glossary-2  
KPDL Errors . . . . . 2-41

## L

LAN Interface . . . . . 2-86  
Loading Paper  
    into the Cassette . . . . . 1-14  
    into the MP (Multi-Purpose) Tray . . . . . 1-16

## M

Memory  
    Expanding memory modules . . . . . 3-3  
    Installing . . . . . 3-4  
    on the status page . . . . . 2-14  
Menu Map Sample . . . . . 2-12  
Menu Selection System . . . . . 2-8  
Message Display

Indicators	2-5
Message language	2-61
Status information	2-4
Mode Selection Menu	2-8
MP Tray	Glossary-2
Paper size	2-29
Paper type	2-30

## N

NetBEUI	Glossary-2
NetWare	Glossary-2
Network Interface	4-3
Setting Network interface card (NIC)	2-47
Network Interface Kit	3-6
Network settings	2-47
FTP (Server)	2-53
HTTP	2-54
LPD	2-54
NetBEUI	2-52
POP3	2-54
Protocol detail	2-52
RAW Port	2-54
Restart network	2-55
SMTP	2-53
SNMP	2-53
SNMPv3	2-53
TCP/IP (IPv4)	2-47
TCP/IP (IPv6)	2-51

## O

Operation Panel	
diagram	2-3
Optional Network settings	2-56
AppleTalk	2-58
Communication	2-59
IPSec	2-58
LAN interface	2-58
MACAddressFilter	2-59
Netware	2-57
Restart network	2-60
TCP/IP	2-57
TCP/IP (IPv6)	2-57
Options	
List	3-2
Outline font	Glossary-3
Override A4/Letter	2-41

## P

Page Set	
Number of copies	2-43
Print orientation	2-44
TIFF/JPEG size	2-45
Wide A4 pitch	2-44
XPS FitTo page	2-45
Paper	
Availability	1-2
Colored	1-11
Envelope	1-10
Guidelines	1-4
Label	1-9

Minimum and maximum sizes	1-3
Postcard	1-10
Preprinted	1-11
Properties	1-5
Recommended makes and types	1-3
Recycled	1-11
Thick	1-11
Transparency	1-8
Paper Feed Source	2-37
Paper Feeder	3-5
Paper Size	1-4
Custom	2-31
Paper Specifications	1-2
Paper Type	1-13
Custom	2-34
POP3	Glossary-3
PostScript	Glossary-3
PPM	Glossary-3
Print	
Custom box list	2-21
Fonts list	2-15
Job accounting list	2-92, 2-93
Menu map	2-11
Network status page	2-105
Option network status page	2-105
RAM disk file list	2-15
SSD file list	2-15
Status page	2-13, 2-104
Print Quality	
EcoPrint mode	2-43
Gloss mode	2-42
Setting	2-42
Print restriction selection	2-90

## R

RAM Disk	2-66
Restart Printer	2-104

## S

Size Dial	2-31
Sleep Level	2-73
Sleep mode	Glossary-3
Special Paper	1-7
Specifications	
Network interface	4-3
Paper	1-2
USB interface	4-2
SSD	2-67, 3-6, Glossary-3
Format	2-67
SSL (Secure Sockets Layer) Server	2-83
Status Page Sample	2-13
Subnet Mask	2-49, Glossary-4

## T

Time Setting	2-62
Timer	
Auto error clear	2-72
Auto panel reset	2-70
Automatic form feed timeout	2-73
Error clear time	2-72

---

Low power .....	2-71
Panel reset .....	2-70
Sleep .....	2-71
Toner Alert Level .....	2-77

## **U**

---

Unit of Measurement .....	2-32
USB Interface .....	4-2
USB Memory .....	2-16

## **W**

---

Wireless Network Interface Kit .....	3-6
WSD-PRINT .....	2-81



**We recommend the use of our own brand supplies.  
We will not be liable for any damage caused by the use of third party supplies in this machine.**





